



# MINIMAX 3

User's manual

SUPAIR SAS  
PARC ALTAÏS  
34 RUE ADRASTÉE  
74650 ANNECY CHAVANOD  
FRANCE

RCS 387956790

Revision index : V1 20/05/2020



Thank you for choosing the Minimax 3. We are glad to be able to share our common paragliding passion with you.

SUPAIR has been designing, producing and selling free flying equipment since 1984. By choosing a SUPAIR product you benefit from almost thirty years of expertise, innovation and listening. This is also our philosophy : working endlessly to develop better products and to maintain a high quality production.



We hope you will find this user's manual comprehensive, explicit and hopefully enjoyable as well. We advise you to read it carefully.

You will find the latest up to date information about this product on our website **[www.supair.com](http://www.supair.com)**.

If you have any further questions, feel free to ask one of our retailers for answers. And naturally, the entire SUPAIR team is at your disposal on **[info@supair.com](mailto:info@supair.com)**.



We wish you many safe enjoyable flying hours, and happy landings

Team SUPAIR



# LIST OF CONTENTS

<b>Introduction</b>	<b>4</b>	Repairs / spare parts	18
<b>Technical specifications</b>	<b>5</b>	Materials	18
<b>Components list</b>	<b>6</b>	Recycling	18
<b>Harness Overview</b>	<b>7</b>	<b>Warranty</b>	<b>19</b>
<b>Accessories assembly</b>	<b>8</b>	<b>Disclaimer</b>	<b>19</b>
Seat plate	8	<b>Pilot's gear</b>	<b>19</b>
Carabiners	8	<b>Shock Absorber</b>	<b>20</b>
<b>Gear packing and tips</b>	<b>9</b>	<b>Service Book</b>	<b>21</b>
<b>Adjustments</b>	<b>10</b>		
The various adjustments	10		
Adjusting the harness	11		
<b>Wing/harness Connection</b>	<b>12</b>		
<b>Inflight behavior</b>	<b>13</b>		
<b>Flight phases</b>	<b>14</b>		
Pre-Flight check	14		
Take-off	14		
In flight	14		
Landing	15		
<b>Towing</b>	<b>15</b>		
<b>Mandatory controls</b>	<b>15</b>		
<b>In case of an incident</b>	<b>16</b>		
<b>Maintenance</b>	<b>17</b>		
Harness cleaning and maintenance	17		
Storage and transport	17		
Product longevity	17		

Welcome to the world of paragliding according to SUPAIR, a world of shared passion.

The MINIMAX 3 is a tandem harness passenger designed with an airbag protection. This harness is designed for intensive and professional use.

The well thought-out design and choice of materials were guided by the same quality and durability objectives.

The MINIMAX 3 harness was certified EN 1651 : 2018 and LTF Nfl II 91/09. Indicating that it meets European and German safety requirements.

After reading this manual, we suggest you to check your harness in static hang-posts to adjust it before your first flight.

**N.B : Three important icons will help you when reading this manual :**



Advice



Caution !



Danger !!

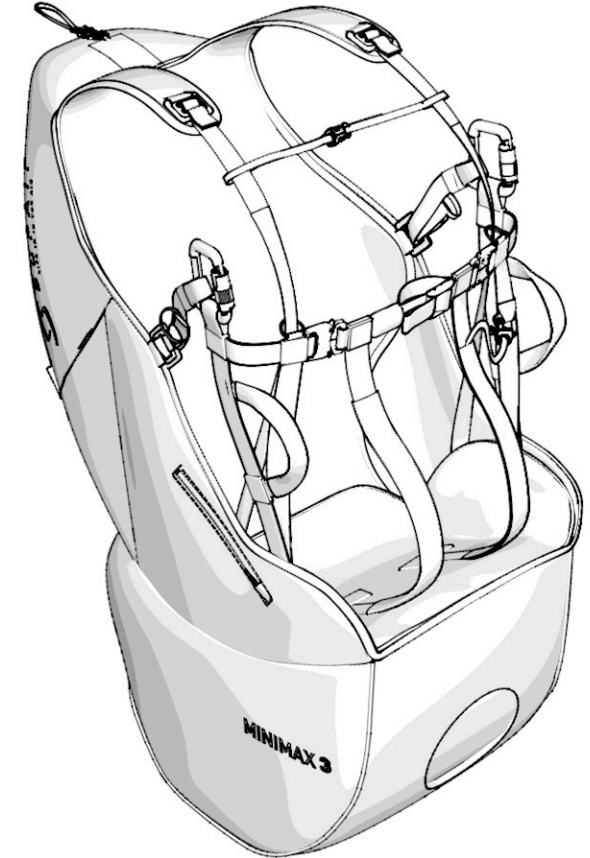

# TECHNICAL SPECIFICATIONS

	Harness size	Unique
	Pilot size (cm)	155-200
	Pilot weight (mini - maxi) (kg)	55 - 110
	Harness weight (+ carabiners+speedbar)(kg)	2875
	Designed for	Tandem
A	Back lenght (cm)	62
B	Backrest tilt adjustment (cm)	34
C	Seat length (cm)	46
D	Seat width (cm)	40
E	Carabiners height (cm)	44
F	Carabiners distance (cm)	38 - 53
	Impact damping system	Airbag
	Certification	EN 1651 : 2018 - LTF Nfl II 91/09
	Tandem (Pilot or Passenger)	Tandem passenger
	Towing	Yes
	Quick-out carabiners compatibility	No
	Reserve parachute pocket volume (litre)	/

**A**

Back lenght

**D**

Seat width

**B**

Backrest tilt adjustment

**E**

Carabiners height

**C**

Seat length

**F**

Carabiners distance

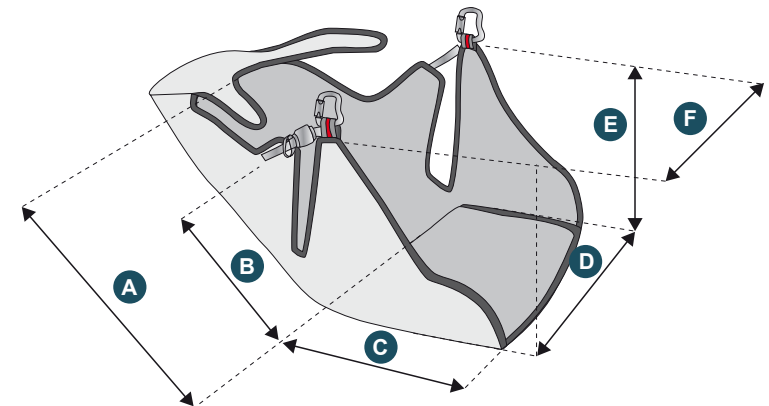



# COMPONENTS LIST

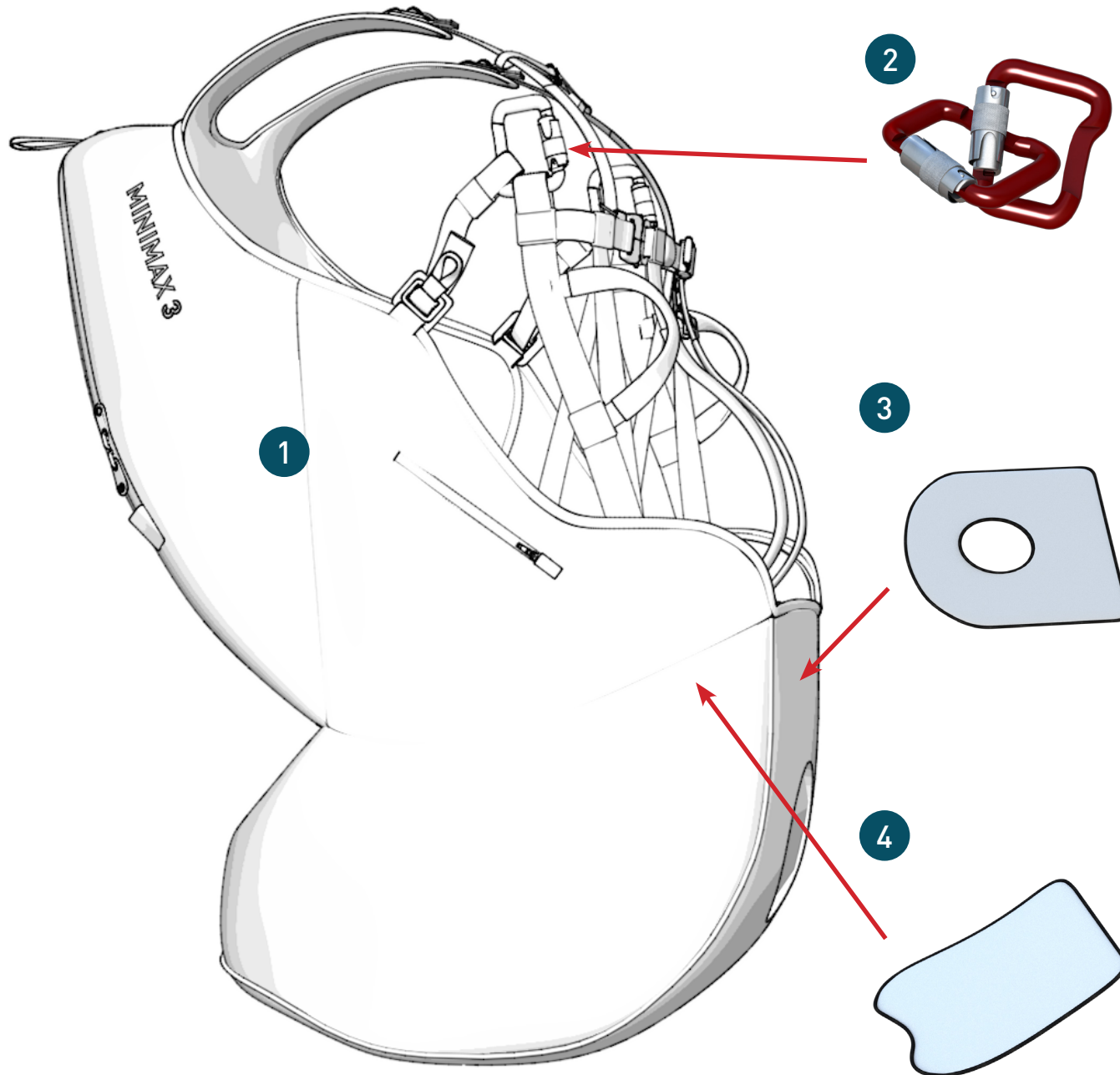

- 1 Harness
- 2 2x 45 mm Zicral self-locking carabiners
- 3 Polypropylene seat plate
- 4 2 x Mylar AIRBAG ( MYABMA )

## Options

Carbon seat plate  
(ref. :seat plate L: 37\*37cm : MPPL007)

Mylar airbag MYABMA  
( ref: PROMYABMA)

Standard rigid spreader bars  
(réf. :ECABISTD2 )

# HARNESS OVERVIEW

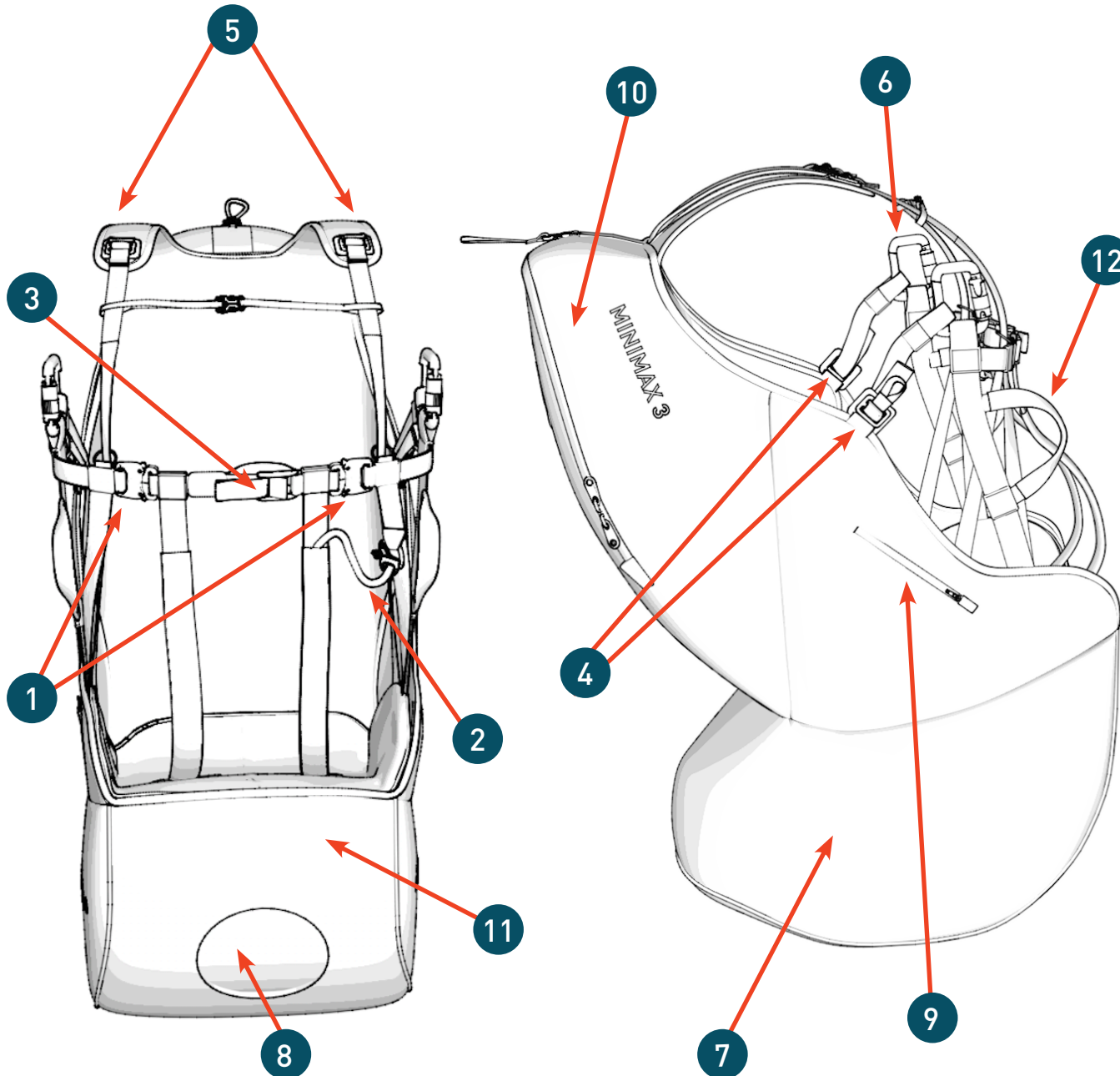

- 1 Chest strap with automatic buckles
- 2 Safe-T-bar
- 3 Chest strap adjustment
- 4 Backrest angle adjustment
- 5 Shoulder strap adjustment
- 6 Paragliding main hooking points
- 7 AIRBAG
- 8 AIRBAG air intake
- 9 Small storage pocket
- 10 Back storage pocket
- 11 Velcro Opening for changing the Mylar
- 12 Passenger handles

# ACCESSORIES ASSEMBLY

## Carabiners

### Compatible carabiners :

45 mm Self-locking zicral carabiners

Réf. : MAILCOMOUS45

Insert the carabiner through the main harness riser connection.

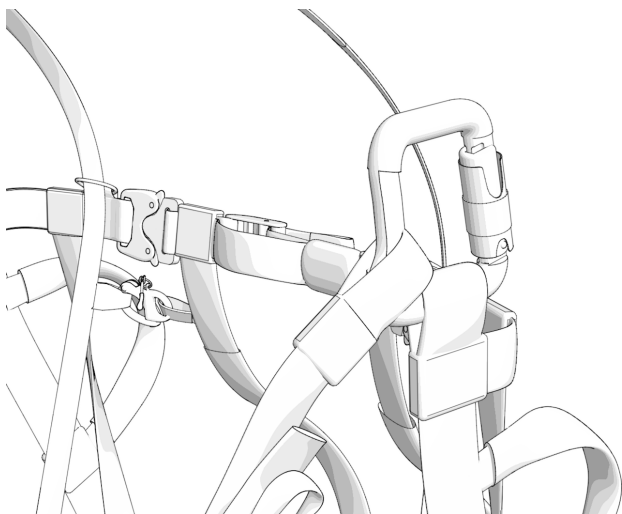
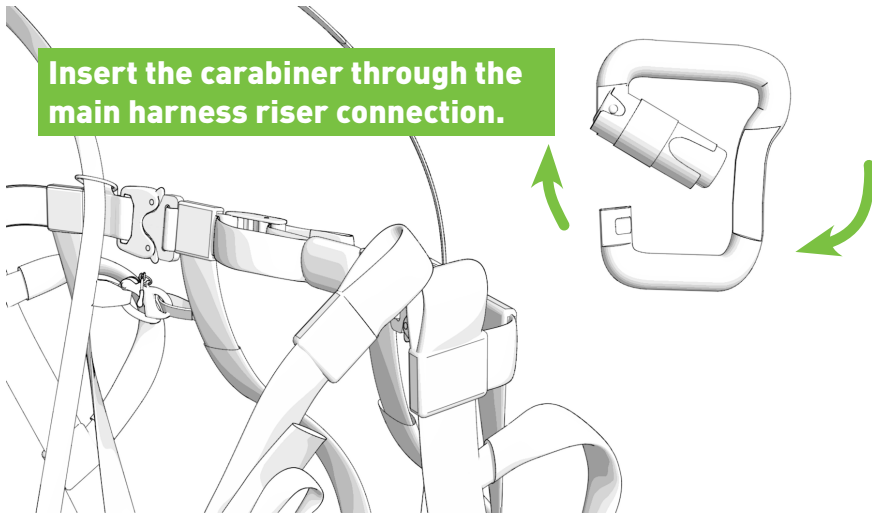

## Seat plate

### Polypropylene seat plate :

Size L Réf. : MPPL032

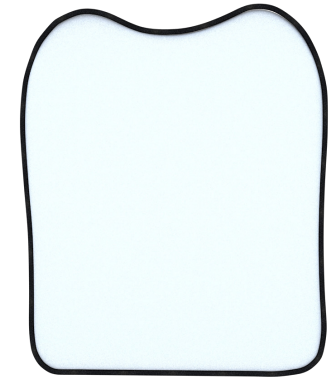

### Installing the seatplate :

1. Turn over the seat
2. Slide the plate under the seat, being careful to put the leg straps behind the plate

Rear

Front

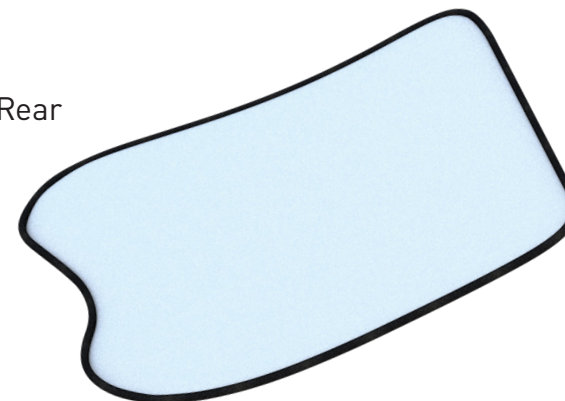

Flight direction →





# PACKING AND TIPS

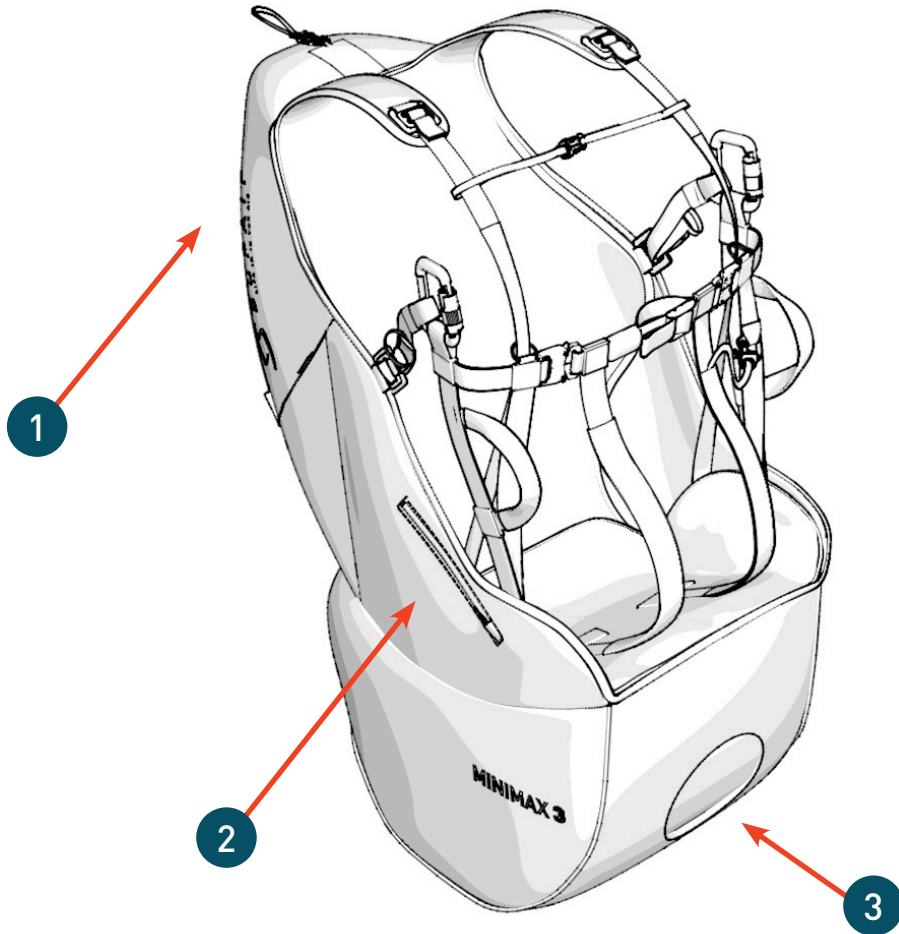

- 1 Back storage pocket
- 2 Small storage pocket
- 3 Interchangeable reinforcement plate



Astuce : Safe-T-Bar

Make a Lark's knot between the leg strap and the safe-T Bar on the loop designed for this purpose.

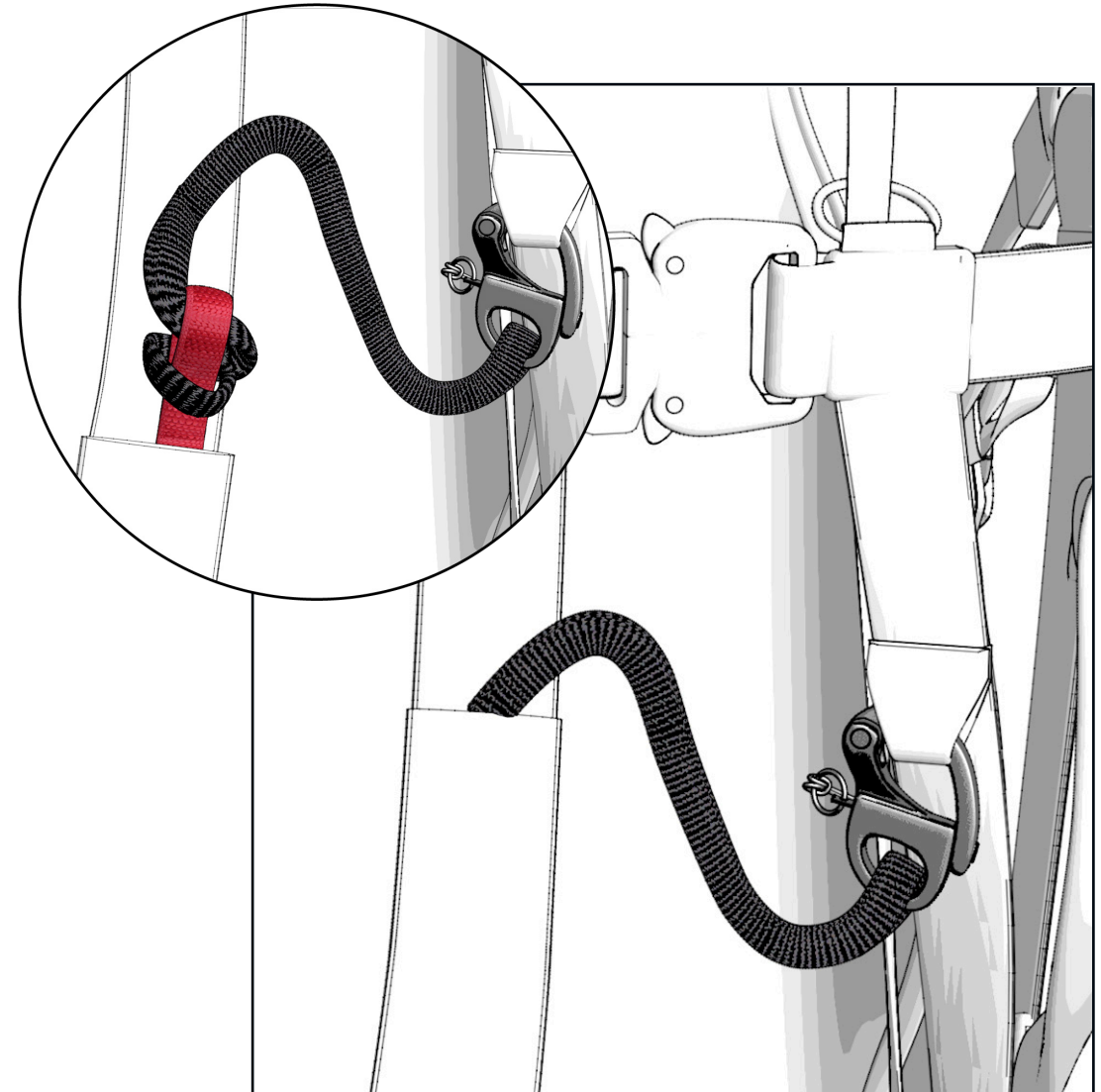

# ADJUSTING THE HARNESS



Adjusting the harness prior each takeoff is vital.

## The various adjustments

- 1 Adjusting the chest strap
- 2 Adjusting the backrest
- 3 Adjusting the shoulder straps

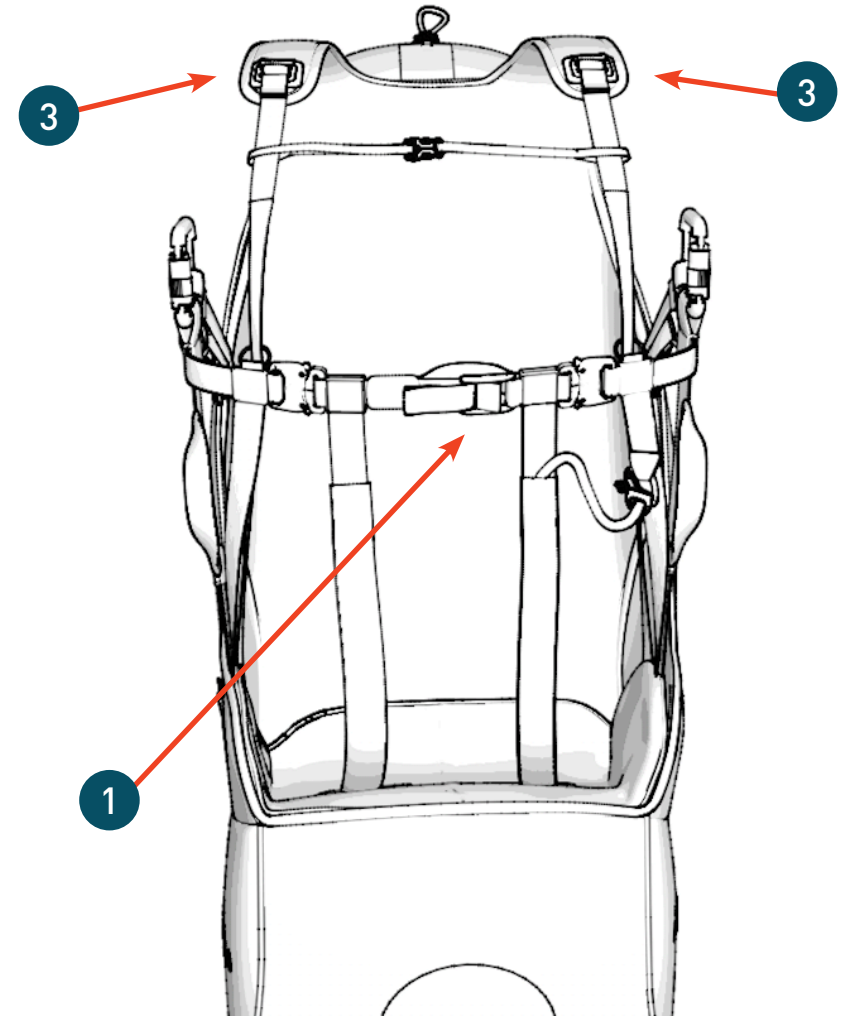
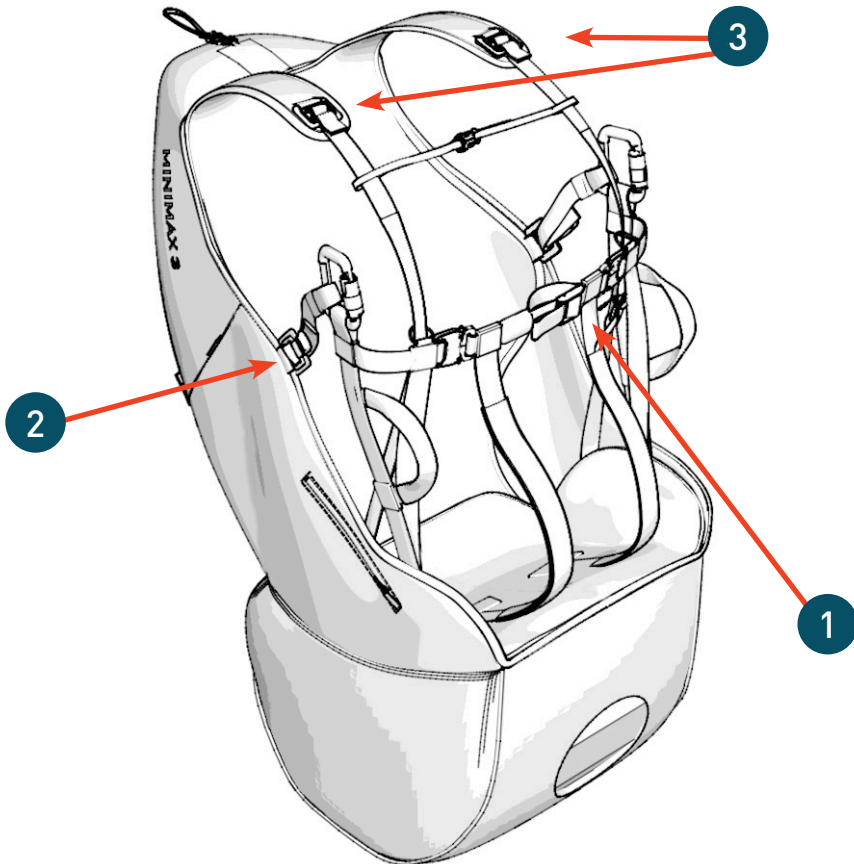

## Adjusting the harness

**Without strap tension, first adjust the backrest incline at the desired angle.**

- Tightening will bring the backrest at a more vertical angle ( recommended posture for beginners ).
- Loosening the backrest will tilt the back support rearward.

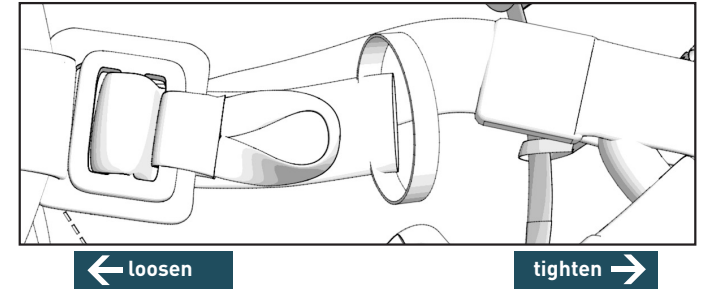

### Adjusting the chest strap :



The distance to consider corresponds to the length between the middle points at the bottom of each carabiner. The ideal distance varies between paragliding wing models. Adjust your harness's chest strap according to the wing manufacturer's recommendations.

Tightening the chest-strap provides more stability but less piloting efficiency while increasing the risk of riser twisting.

On the contrary loosening the strap provides more efficiency but can be dangerous in turbulent aerology (increased risk of falling towards the collapsed side of your glider).

To get a "standard" adjustment, the two red marks located on the Safe-T-Bar and on the chest adjustment strap should be matched together.



### Adjust the shoulder straps length using the trimmers

The pressure on the shoulder straps contributes to general comfort in flight. It must be precise: not too tight nor too loose. The upper area of the straps must offer enough support to maintain your torso in a comfortable position.

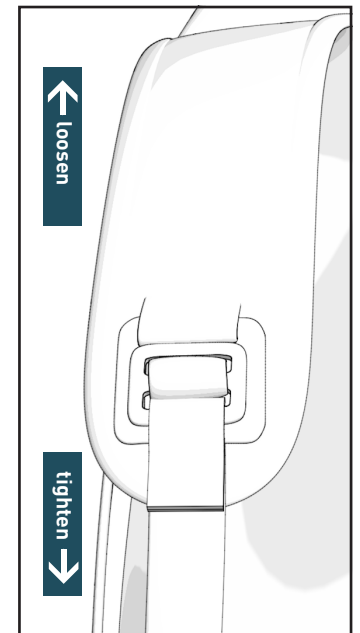

# CONNECTING THE WING TO THE HARNESS

## Connecting the wing to the spreader bars

Connect the Minimax 3 to the spreader bars on the loop meant for that purpose

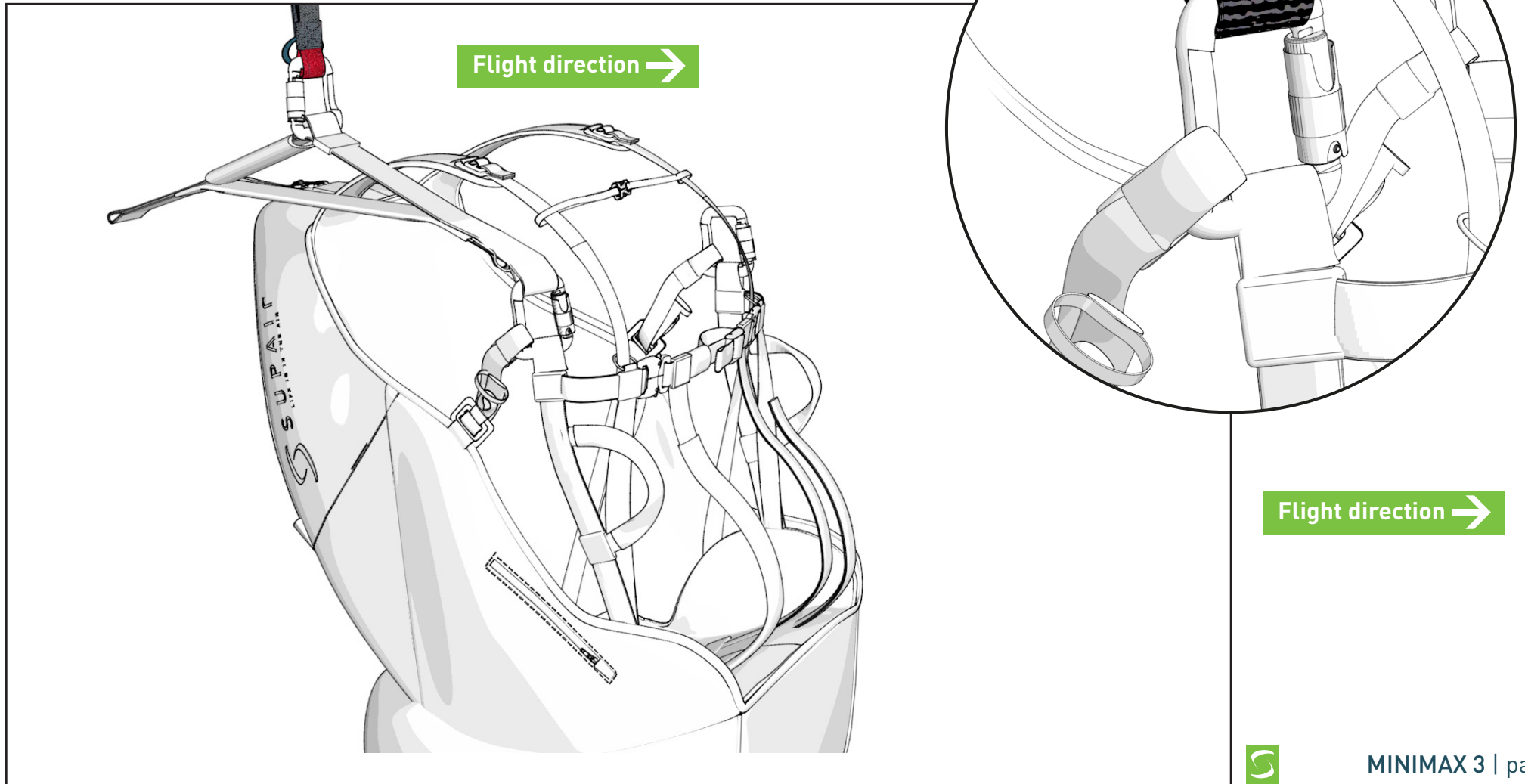



# FLIGHT BEHAVIOR



The Minimax 3 is a stable and comfortable tandem harness passenger, with an easy transition between seated and stand-up position

The Minimax 3 harness has been designed for professional tandem pilots as well as leisure pilots

To learn more about this harness, we advise you to carry out the first flights with it in stable conditions, preferably flying on-site or in an area that you are familiar with.



## Pre-Flight control



- Check that the harness, the carabiners, the spreader bar and in general all your flight equipment are not damaged. As the captain, you are responsible for the safety of the crew
- Check that your personal settings haven't changed.
- Check that all zippers and buckles are closed.
- Check that none of the glider lines or any object come into contact with the reserve parachute handle(s).

## Take-off

After a thorough weather conditions analysis, when the decision to fly has been taken, put your harness on and follow the next steps



- Lock the buckles fastening leg and chest straps

Takeoff maintaining a vertical posture and push yourself inside the harness but only once away from the ridge.



Do not release your hands from the brakes when you are close to terrain.



## In flight



Once up in the air, the MINIMAX 3 behaviour is stable and instinctive. Please set the distance between the two carabiners according to aerology and to the wing manufacturer's recommendations.

## Landing



Straighten yourself in your harness and adopt a running posture to dissipate the horizontal speed.

Always be certain to have enough altitude to make a landing approach corresponding to the weather conditions of the moment and terrain. During the landing approach, never make hasty maneuvers. Always land upwind in a standing posture and be ready to run upon touchdown if necessary.

During your final approach, use as much airspeed as possible based on the weather conditions of the moment, then gradually reduce the glider air speed by pushing the toggles all the way down until contact with the ground is made. **Beware not to brake too soon and too rapidly and too deep which could lead to a stall and a dangerous landing.**

During high wind speed landings, turnaround and face the wing as soon as ground contact is made and move toward the wing while braking symmetrically to deflate it. **Do not land in a seated position as it is dangerous.**

## TOWING

To takeoff under tow, you must be equipped with a quick release specially designed for the task.

Connect the tow bridle to the wing riser loops with a suitable tow bridle. Installation must follow the tow bridle manufacturer's recommendations. Before towing, you should consult with a competent towing outfit about safety recommendations.

## MANDATORY CONTROLS

### Mandatory biannual inspection :



- Inspect the harness for wear and tear

## Call for help after an accident

### Emergency call numbers



EUROPE / INDIA	112
USA / CANADA	911
CHINA / JAPAN	119
NEPAL	101
IRAN	112
AUSTRALIA	000
NEW ZEALAND	111

### Help needed?

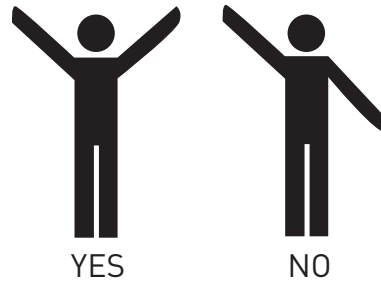

### Flashlight SOS :



## Harness cleaning and maintenance

It is a good idea to clean your harness from time to time. We recommend using a brush and soft solvents only ( soap or mild cleaning agents ). Rinse thoroughly. Never use aggressive chemicals such as strong solvents which could be harmful to the harness's fabric, webbings, stitching and weaken its integrity.

The zip fasteners should be lubricated from time to time, using a silicon spray.

If you regularly use your harness in a dusty environment ( dirt, sand, etc... ), we advise you to regularly check and maintain your carabiners and buckles : clean them with a mild detergent, then blow dry them fully but **DO NOT LUBRICATE !**

Prior to using them, conduct a thorough carabiners and buckles checkup to insure their full functionality.

If you use your harness in a marine/sandy/salty environment, pay particular attention to your gear and follow a rigorous care/maintenance routine.

## Storage and transport

When not in use, your harness should be stored inside your paragliding backpack, in a dry, cool and clean place, protected from UV exposure. If your harness is wet, please dry it thoroughly before storing.

For transport, protect the harness from any mechanical or UV deterioration (use a bag). Please avoid long transports in wet conditions.

## Life span



Once every two (2) years, a thorough harness inspection must be conducted :

- Webbing wear and tear (no excessive wear, no rip beginning, no unwanted folds)
- Buckles and carabiners ( functionality, wear and tear ).



The threads and fabric used for the manufacturing of the MINIMAX 3 were specifically selected for their quality and resilience levels. However, in particular instances such as long term UV exposure, abrasion, contact with damaging chemicals, general wear and tear, the harness will need to be inspected at a professional certified repair facility. Safety comes first!



Supair advice to replace the carabiners and spreader bars every 5 years or after 500 hours of use.

The self-locking carabiners are NEVER to be used for any activities other than paragliding.

## Repair

In spite of using the highest quality products to manufacture the MINIMAX 3, it is possible for your harness to deteriorate through general use. If showing any sign of wear and tear, it should be sent for inspection and/or repairs at a professional certified facility.



SUPAIR now offers an extended warranty period reaching beyond the product standard protection plan against manufacturing defects. Please contact us either by telephone or by e-mail [sav@supair.com](mailto:sav@supair.com) in order to receive a quotation..

## Hardware & Parts

- Self-locking zicral 45mm carabiners ( Reference:MAILCOMOUS 45)
- Polypropylene seat plate ( L : MPPL032 )
- Mylar airbag MYABMA ( ref PROMYABMA)

## Materials

Fabrics

Nylon ripstop 210D  
Cordura 500D

Webbings

PES 25mm (1250 daN)

## Recycling

We have minimized our manufacturing footprint by carefully selecting environmentally friendly materials; most of our components are recyclable.

If you estimate that your MINIMAX 3 has reached the end of its life span, you can separate plastics from metals and recycle them according to your community rules in effect. As for the fabric itself, contact your local authorities to find out how to proceed to discard it.



## WARRANTY

SUPAIR takes the greatest care in its products design and manufacturing and hence offers a five (5) year limited warranty from the date of purchase against manufacturing defects or flaws occurring during normal use. Any damage or degradation resulting from incorrect or abusive use, abnormal exposure to aggressive factors, including, but not limited to; high temperature, intense sun exposure, high humidity etc, will invalidate this warranty.

## DISCLAIMER



Paragliding is an activity requiring specific skills and sound judgement. Learn how to fly within the environment of a certified paragliding school. Carry an insurance policy with you in addition to your pilot certification. Always mind and gauge your personal skills relative to the elements you want to be flying in. Better be safe than sorry ! SUPAIR can not be held responsible for your paragliding decisions or activities.



**This SUPAIR product has been designed exclusively for paragliding. Any other activity such as skydiving or BASE jumping is absolutely forbidden.**

## PILOT'S GEAR



It is essential for you to wear a suitable head protection ( certified paragliding helmet ), boots and right clothing for the activity. Moreover, carrying a reserve parachute connected to your harness in flight is highly recommend.

## AIRBAG Shock Absorber

The harness you have just purchased has a AIRBAG type shock absorber.

This protection is intended to protect you against potential impacts. It complies with EU Regulations 2016/425 relating to personal protective equipment (PPE).

The shock absorber CE conformity of your harness is certified by the following laboratory: ALIENOR CERTIFICATION n ° 2754, Z.A. du Sanital, 21 Rue Albert Einstein, 86100 Chatellerault, FRANCE

The storage, transport and maintenance of the AIRBAG is the same as it is for the harness. The inspection of the protector is the same as it would be for the harness.



Please note that no shock absorber can guarantee total protection against injury. The back protector does not prevent potential injuries to the spine and/or pelvis. In addition, only the parts of the body covered by the shock absorber are likely to benefit from adequate protection against possible impacts.



Please note that the performance of the equipment can be dangerously affected by any modification made or improper use of the shock absorber, and negatively affect the proper functionality of the protector which must be whole and properly installed. You must check that all is in order prior each flight:

- The correct shape and inflation of the AIRBAG/shock absorber.
- The AIRBAG seams and overall condition of the fabrics - look for holes, tears, snags ....



The protection can have a five (5) year lifespan under normal use conditions.  
Warning! Following a major hard landing would justify the protector to be discarded.

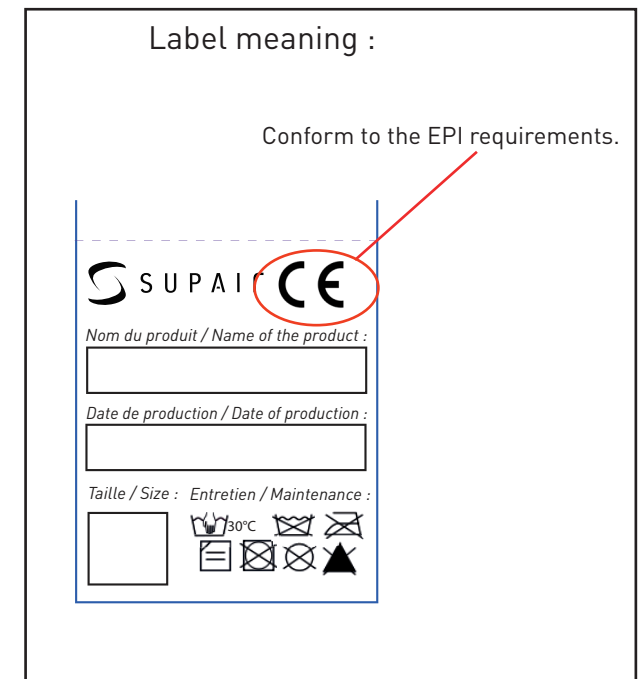

If your AIRBAG is damaged, have it inspected and repaired at a professional qualified facility or contact us at [sav@supair.com](mailto:sav@supair.com)

The test results and the EU declaration of conformity can be found at: [www.supair.com](http://www.supair.com)

This page will help you keep record of your MINIMAX 3 scheduled maintenance.

Purchase date	
Owner's name :	
Name and stamp of the shop :	

<input type="checkbox"/> Care	
<input type="checkbox"/> Resale	
Date	
Workshop's name/ Buyer's name	

<input type="checkbox"/> Care	
<input type="checkbox"/> Resale	
Date	
Workshop's name/ Buyer's name	

<input type="checkbox"/> Care	
<input type="checkbox"/> Resale	
Date	
Workshop's name/ Buyer's name	

<input type="checkbox"/> Care	
<input type="checkbox"/> Resale	
Date	
Workshop's name/ Buyer's name	



SUPAIR-SAS  
Parc Altaïs  
34 rue Adrastée  
74650 Chavanod, Annecy  
FRANCE

[info@supair.com](mailto:info@supair.com)  
+33 4 50 45 75 29

RCS 387956790

■ ■ DESIGNED  
■ ■ IN ANNECY

 100% MADE  
IN EUROPE