

 SUPAIR

English



# LOUSTIC 2

User's manual

SUPAIR SAS  
PARC ALTAÏS  
34 RUE ADRASTÉE  
74650 ANNECY CHAVANOD  
FRANCE

RCS 387956790

Indice de révision : V1 15/12/2020



Thank you for choosing the Loustic 2. We are glad to be able to share our common paragliding passion with you.

SUPAIR has been designing, producing and selling free flying equipment since 1984. By choosing a SUPAIR product you benefit from almost thirty years of expertise, innovation and listening. This is also our philosophy : working endlessly to develop better products and to maintain a high quality production.

We hope you will find this user's manual comprehensive, explicit and hopefully enjoyable as well. We advise you to read it carefully.

You will find the latest up to date information about this product on our website [www.supair.com](http://www.supair.com).

If you have any further questions, feel free to ask one of our retailers for answers. And naturally, the entire SUPAIR team is at your disposal on [info@supair.com](mailto:info@supair.com).

We wish you many safe enjoyable flying hours, and happy landings

Team SUPAIR

# LIST OF CONTENTS

<b>Introduction</b>	<b>4</b>
<b>Technical specifications</b>	<b>5</b>
<b>Size choice</b>	<b>6</b>
<b>Components list</b>	<b>6</b>
<b>Harness Overview</b>	<b>7</b>
<b>Accessories assembly</b>	<b>8</b>
Seat plate	8
Carabiners	8
Comfort foam	9
<b>Adjustments</b>	<b>10</b>
The various adjustments	10
Adjusting the harness	11
<b>Spreader bars/harness Connection</b>	<b>12</b>
<b>Flight phases</b>	<b>13</b>
Pre-Flight check	13
Take-off	13
In flight	13
Landing	14
<b>Towing</b>	<b>14</b>
<b>Mandatory controls</b>	<b>14</b>
<b>In case of an incident</b>	<b>15</b>
<b>Maintenance</b>	<b>17</b>
Harness cleaning and maintenance	16
Storage and transport	16
Product longevity	16

Repairs / spare parts	17
Materials	17
Recycling	17
<b>Warranty</b>	<b>18</b>
<b>Disclaimer</b>	<b>18</b>
<b>Pilot's gear</b>	<b>18</b>
<b>Service Book</b>	<b>19</b>

Welcome to the world of paragliding according to SUPAIR, a world of shared passion.

This harness has all the makings of a great one. However, it is a passenger tandem harness and not a solo harness: your presence as a pilot and your knowledge of tandem flying are required.

Please also observe the flying and insurance regulations for tandem flights applicable in your country.

The well thought-out design and choice of materials were guided by the same quality and durability objectives.

The LOUSTIC 2 harness was certified EN 1651 : 2018 and LTF Nfl II 91/09. Indicating that it meets European and German safety requirements.

After reading this manual, we suggest you to check your harness in static hang-posts to adjust it before your first flight.

**N.B : Three important icons will help you when reading this manual :**



Conseil.



Attention !



Danger !!

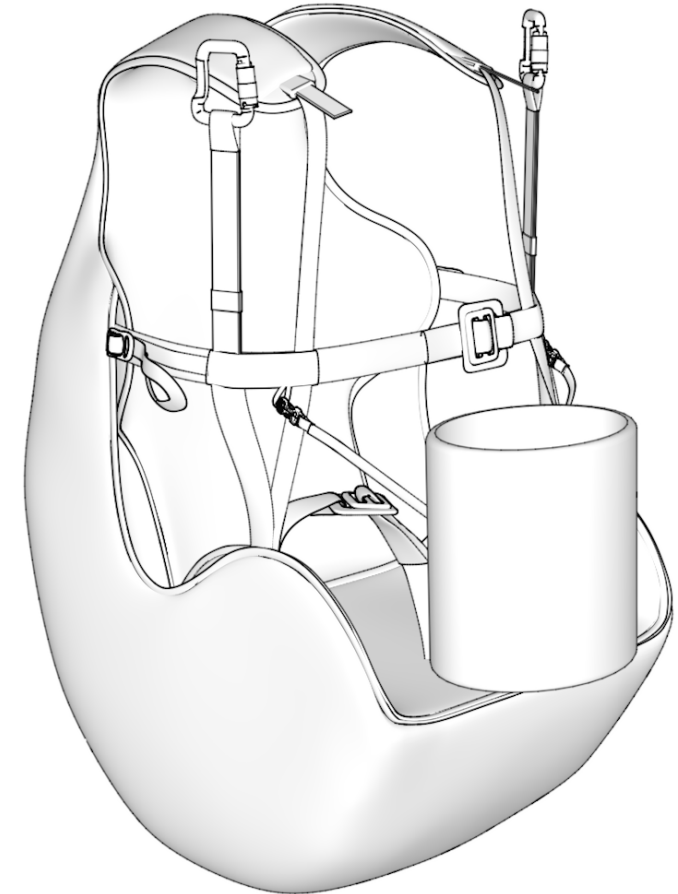

# TECHNICAL SPECIFICATIONS

	Harness size	Unique
	Pilot size (cm)	80 - 110
	Pilot weight (mini - maxi) (kg)	8 - 20
	Harness weight (+ carabiners+speedbar)(kg)	1,15 kg
	Designed for	Paragliding only
A	Back lenght (cm)	35
B	Backrest tilt adjustment (cm)	25
C	Seat length (cm)	21
D	Seat width (cm)	25
E	Carabiners height (cm)	31/47
F	Carabiners distance (cm)	33
	Back protection	No
	Certification	EN 1651 - LTF
	Maximum in flight weight ( certification )	50 kg
	Tandem (Pilot or Passenger)	Yes
	Aerobatic flying	NO
	Towing	Yes
	Reserve parachute	No

**A**

Back lenght

**D**

Seat width

**B**

Backrest tilt adjustment

**E**

Carabiners height

**C**

Seat length

**F**

Carabiners distance

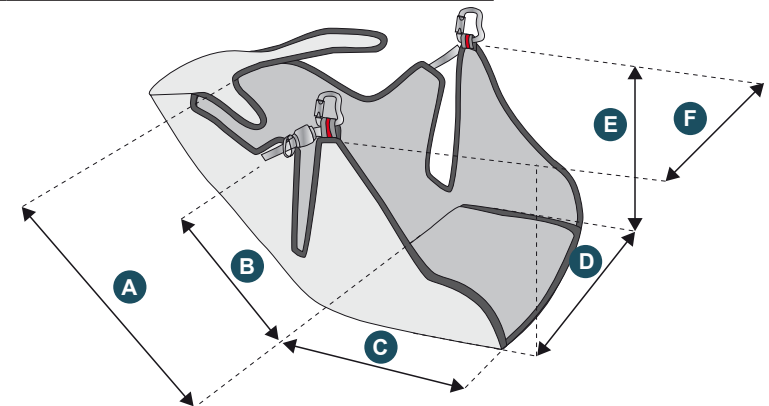

# SIZE CHOICE

The LOUSTIC 2 is available in one size.

It covers an age range from 3 to 6 years, but as children vary greatly in size and build at these ages, it is advisable to try it out under a gantry before purchase.

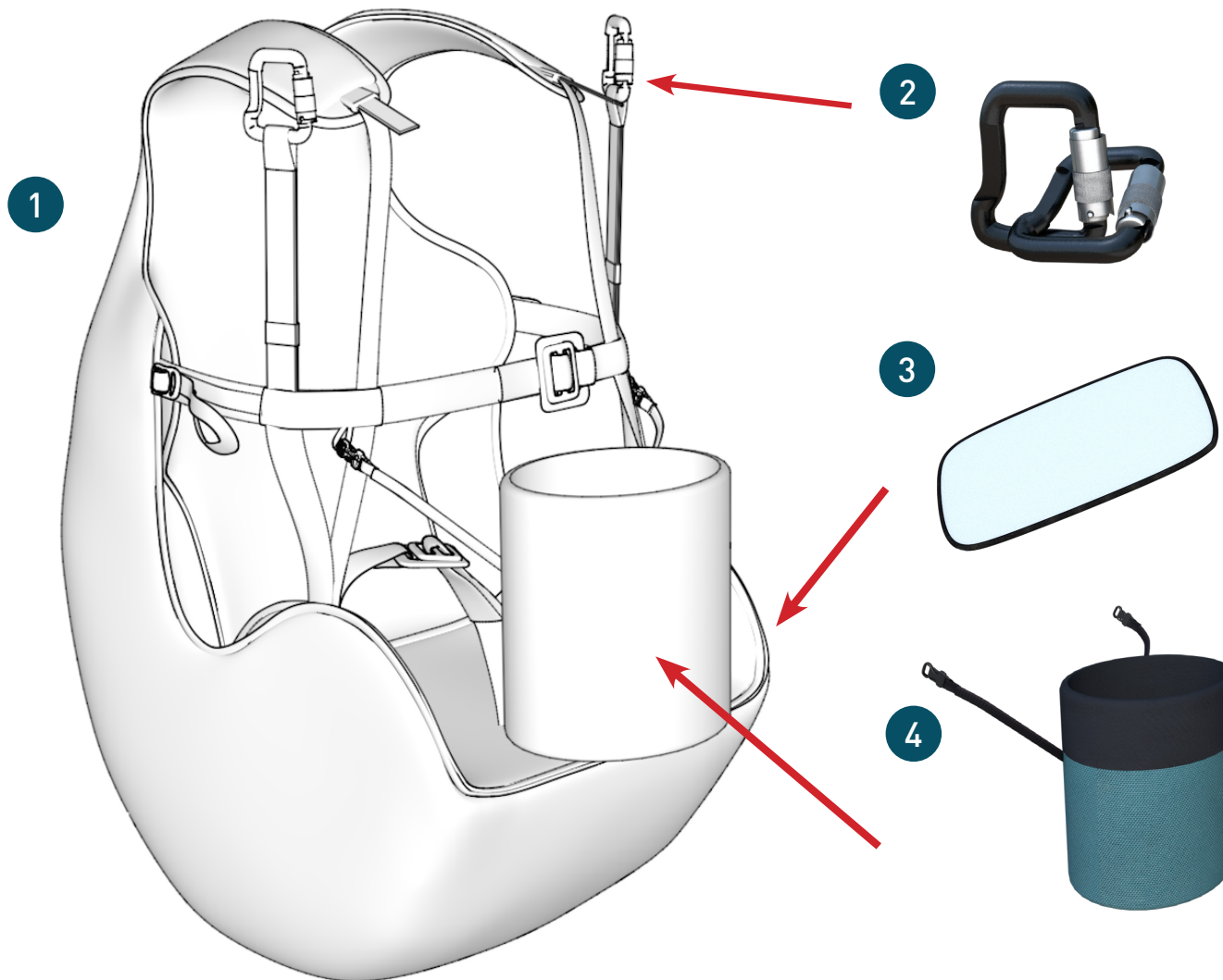

## COMPONENTS LIST

- 1 Harness
- 2 2x 30 mm Zical self-locking carabiners
- 3 Polypropylene seat plate
- 4 Teddy bear pocket

# HARNESS OVERVIEW

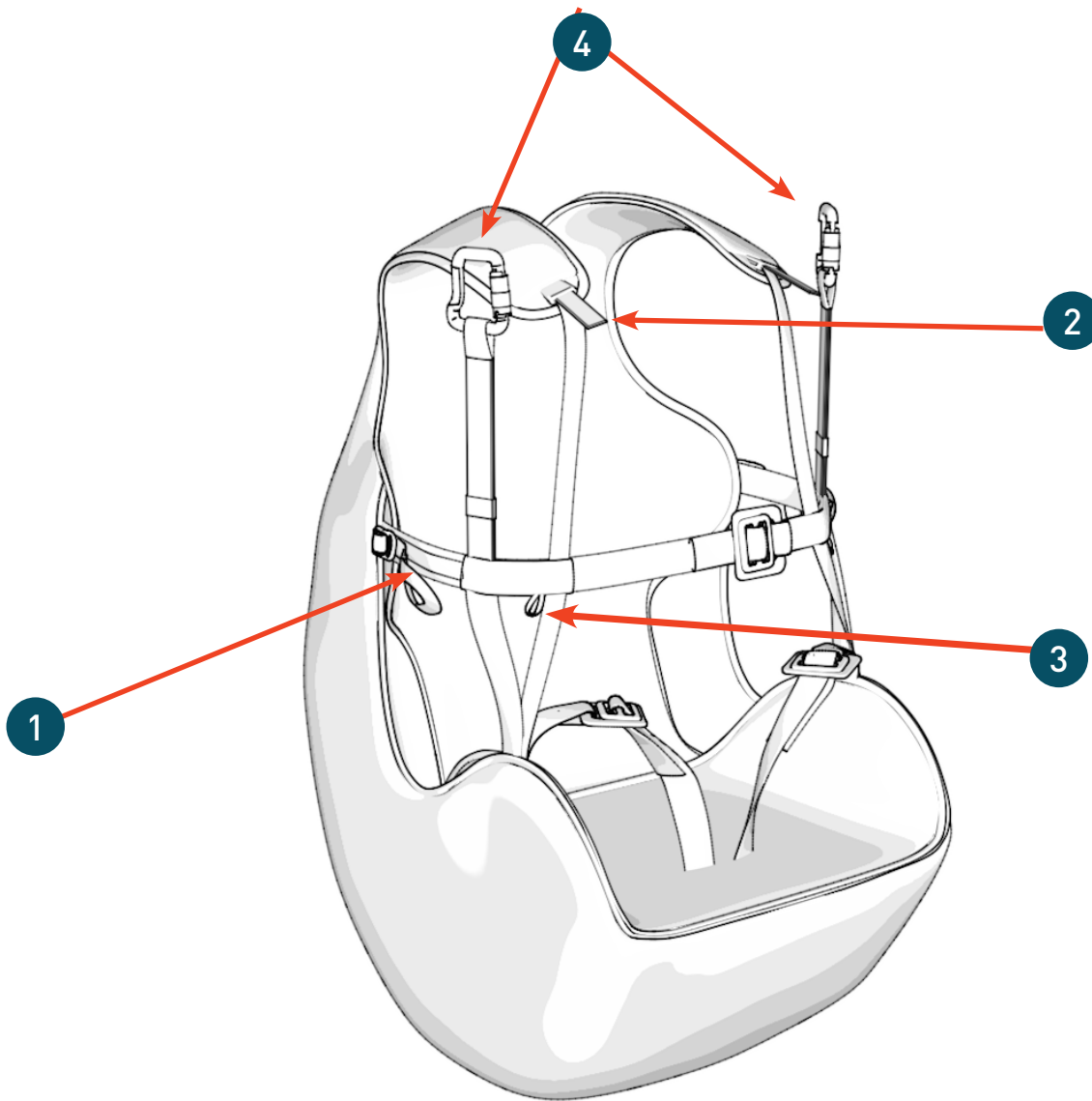

- 1 Backrest angle adjustment
- 2 Shoulder strap adjustment
- 3 Teddy bear pocket fastening
- 4 Main hooking points

# ACCESSORIES ASSEMBLY

## Carabiners

### Compatible carabiners :

30 mm Self-locking zicral carabiners

Réf. : MAILCOMOUS30

Insert the carabiner through the main harness riser connection.

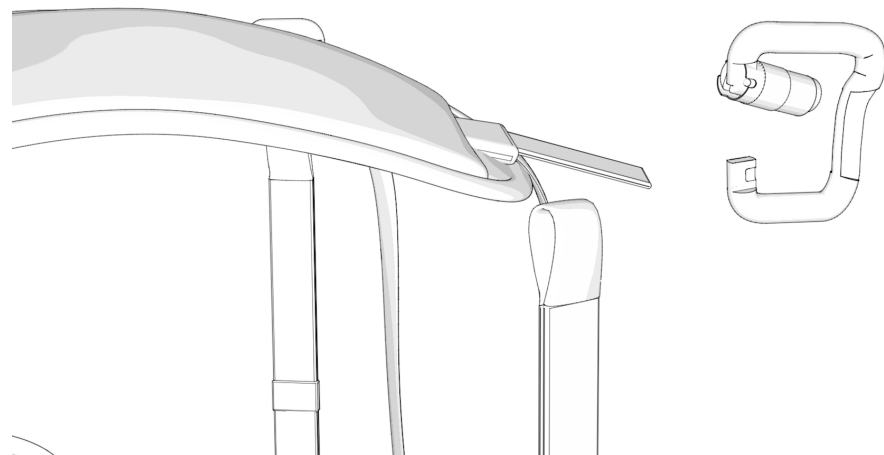
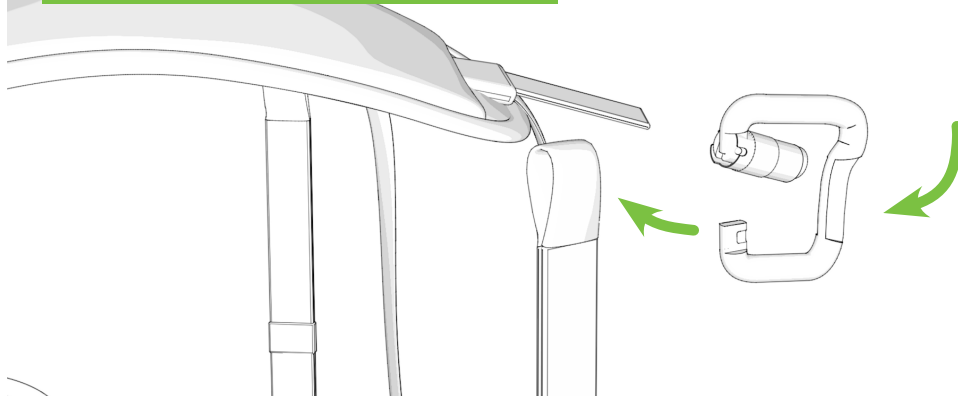

## Seat plate

LS2 polypropylene seat plate :

Réf. : MPPL036

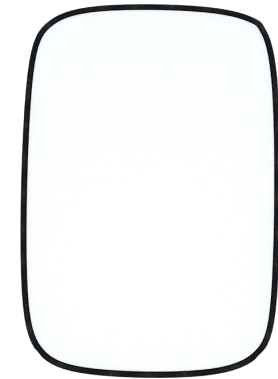

### Installing the seatplate :

1. Turn over the seat
2. Slide the plate under the seat, being careful to put the leg straps behind the plate

Rear

Front

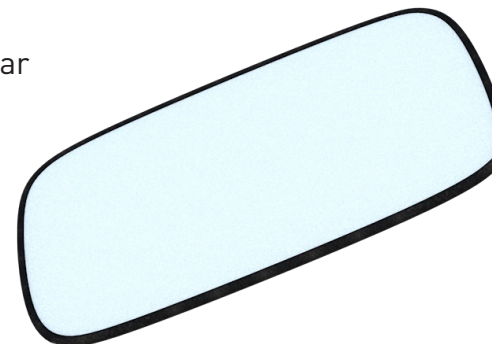

Flight direction →





## COMFORT FOAM

Insert the foam behind the seat and place the side velcros on the foam.

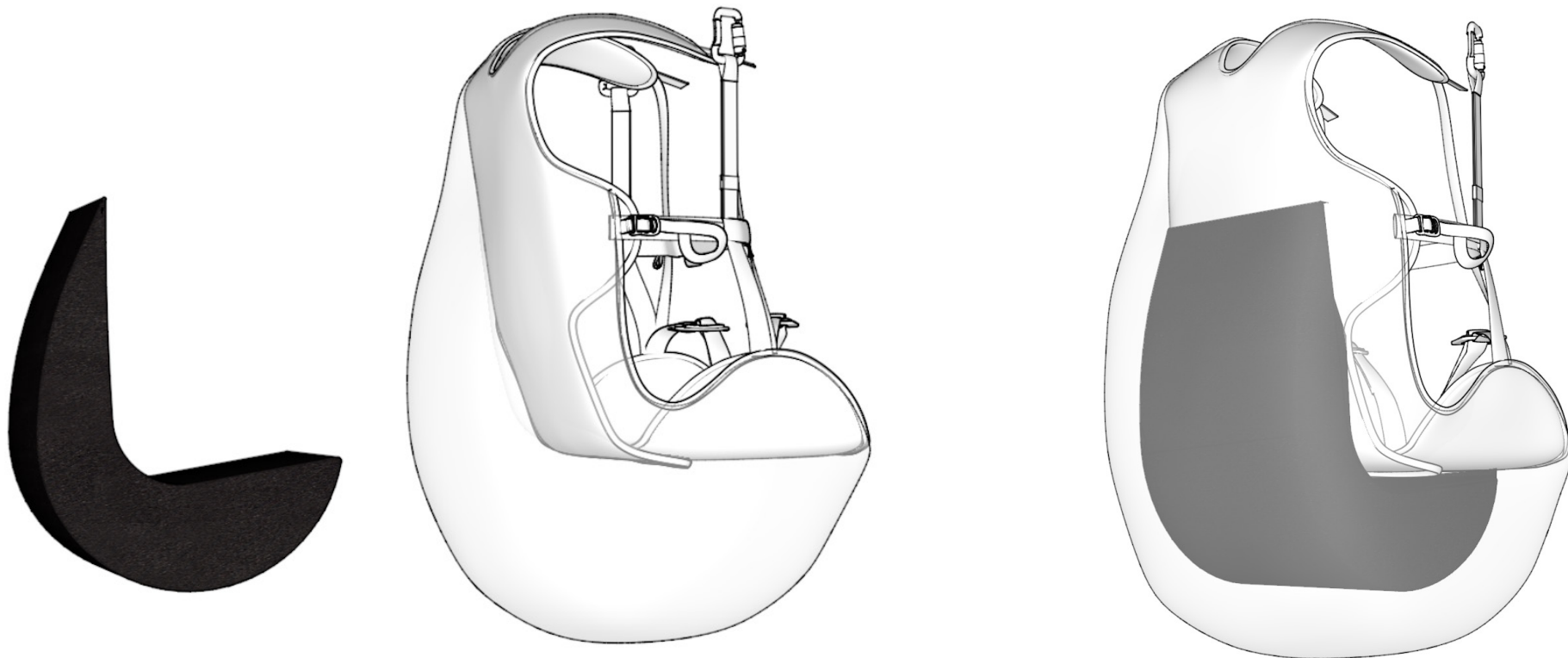



Important : Adjusting the harness prior each takeoff is vital.

## The various adjustments

- 1 Adjusting the backrest
- 2 Adjusting the shoulder straps

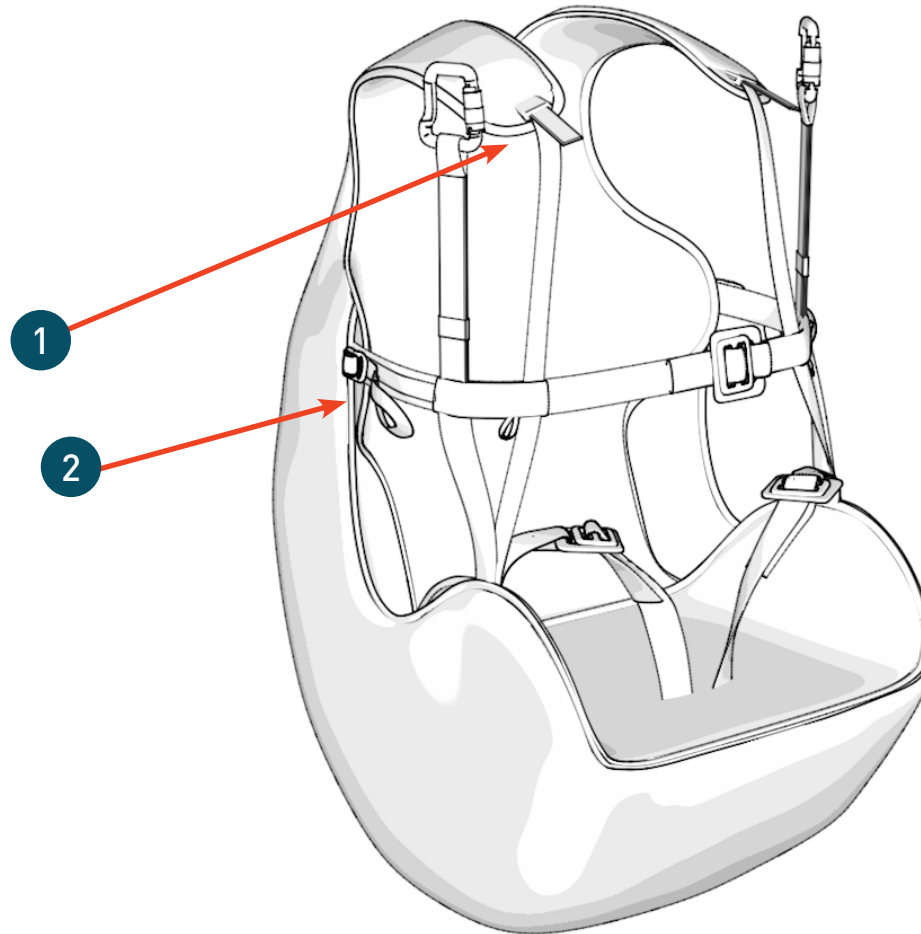

## Adjusting the harness

**Without strap tension, first adjust the backrest incline at the desired angle.**

- Tightening will bring the backrest at a more vertical angle ( recommended posture for beginners ).
- Loosening the backrest will tilt the back support rearward.

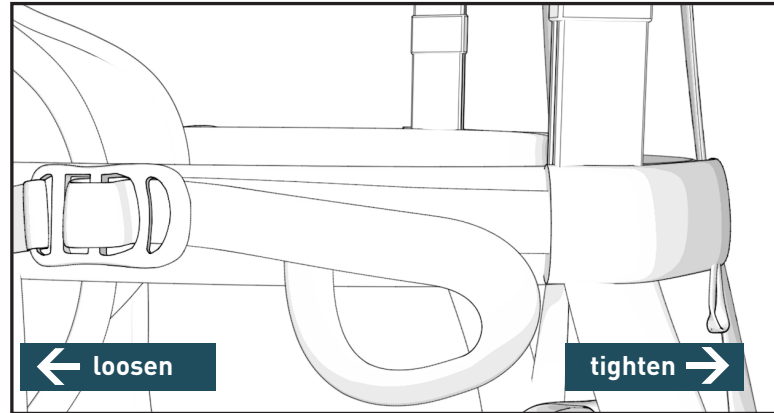

### Adjust the shoulder straps length using the trimmers

The pressure on the shoulder straps contributes to general comfort in flight. It must be precise: not too tight nor too loose. The upper area of the straps must offer enough support to maintain your torso in a comfortable position.

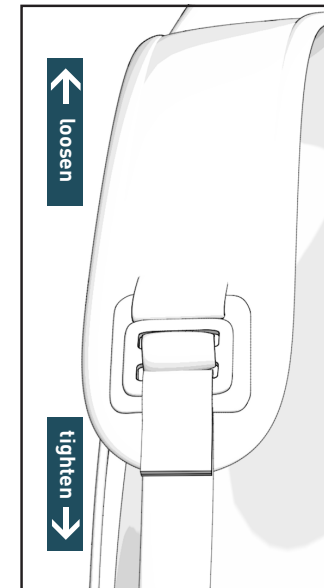

# CONNECTING THE WING TO THE HARNESS

Rigid spreader bars position

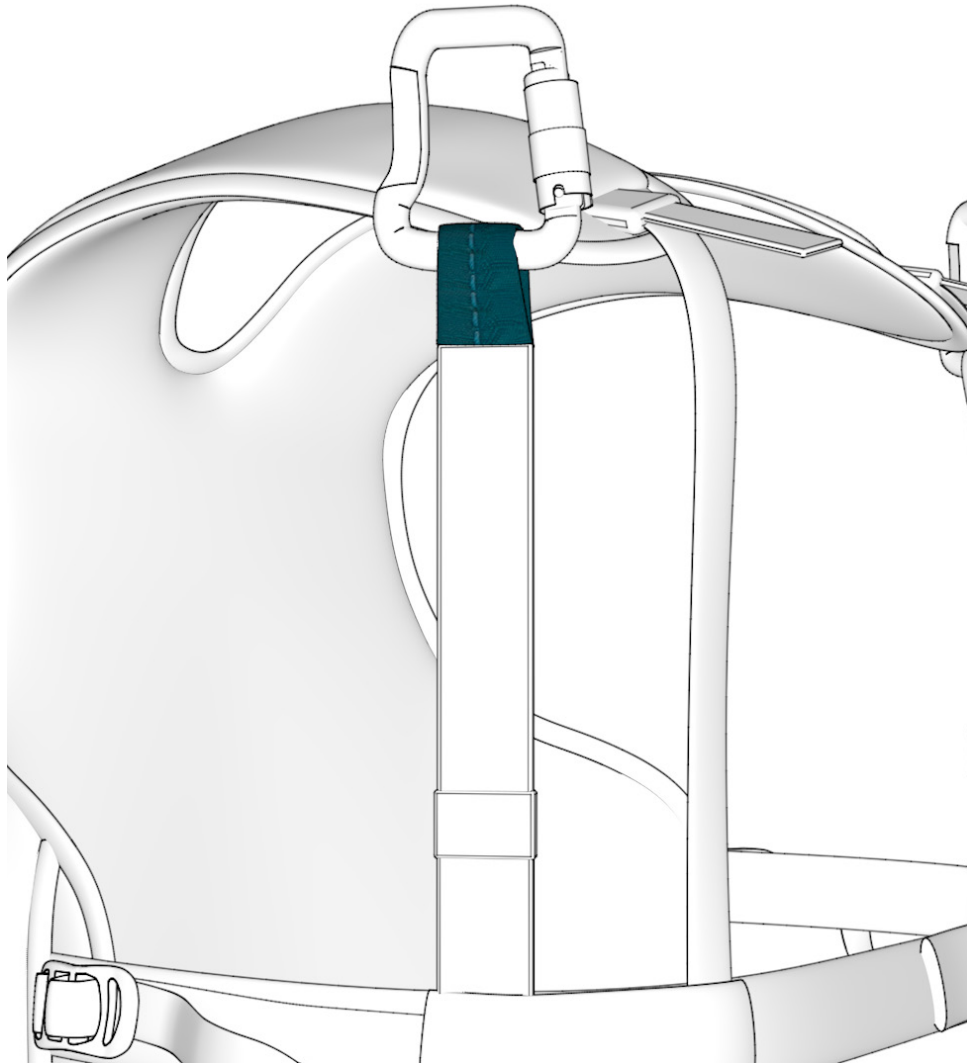

Soft spreader bars position

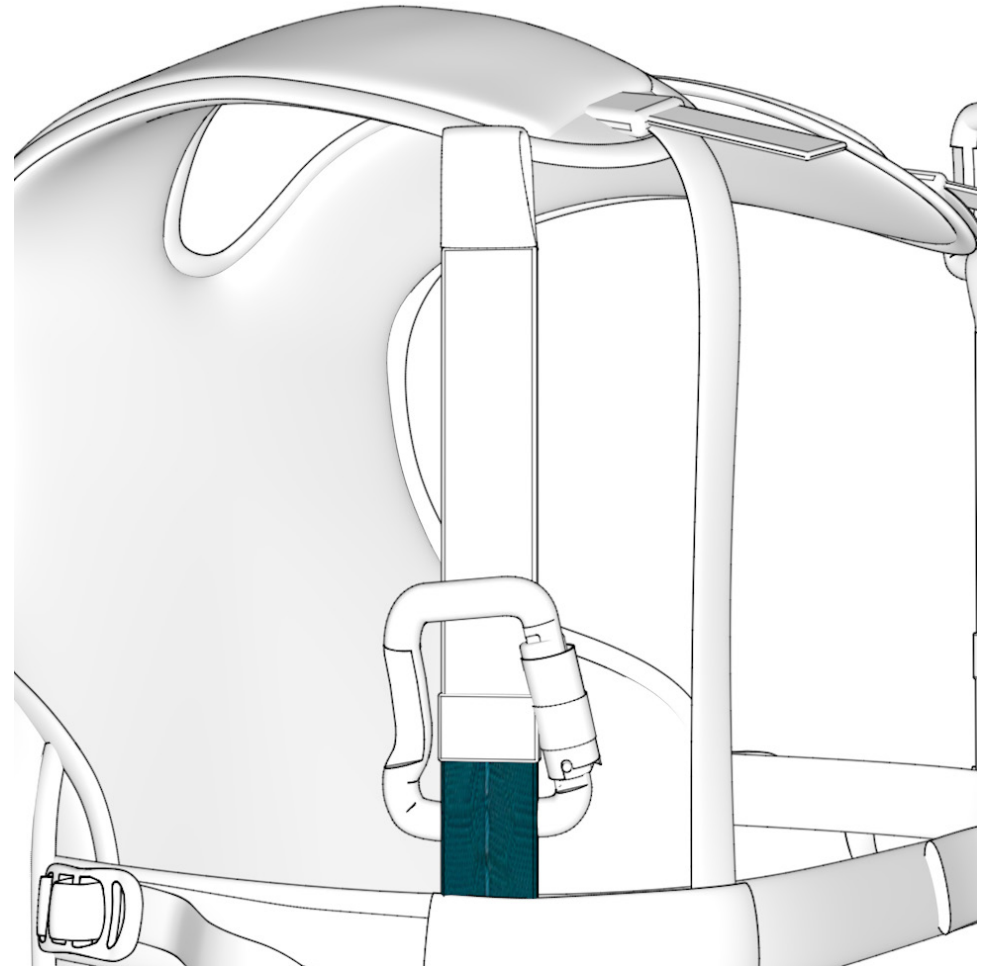

## Pre-Flight control



- Check that the harness, the carabiners, the spreader bar and in general all your flight equipment are not damaged. As the captain, you are responsible for the safety of the crew
- Check that your personal settings haven't changed.
- Check that all zippers and buckles are closed.
- Make sure that the self-locking carabiners are locked and connected to the paraglider.

## Take-off

After a thorough weather conditions analysis, when the decision to fly has been taken, put your harness on and follow the next steps



- Lock the buckles carefully.

Takeoff maintaining a vertical posture and push yourself inside the harness but only once away from the ridge.



Do not release your hands from the brakes when you are close to terrain.



## In flight



Once up in the air, the LOUSTIC 2 behaviour is stable and instinctive.

## Landing



Straighten yourself in your harness and adopt a running posture to dissipate the horizontal speed.

Always be certain to have enough altitude to make a landing approach corresponding to the weather conditions of the moment and terrain. During the landing approach, never make hasty maneuvers. Always land upwind in a standing posture and be ready to run upon touchdown if necessary.

During your final approach, use as much airspeed as possible based on the weather conditions of the moment, then gradually reduce the glider air speed by pushing the toggles all the way down until contact with the ground is made. **Beware not to brake too soon and too rapidly and too deep which could lead to a stall and a dangerous landing.**

During high wind speed landings, turnaround and face the wing as soon as ground contact is made and move toward the wing while braking symmetrically to deflate it. **Do not land in a seated position as it is dangerous.**

## TOWING

To takeoff under tow, you must be equipped with a quick release specially designed for the task.

Connect the tow bridle to the wing riser loops with a suitable tow bridle. Installation must follow the tow bridle manufacturer's recommendations. Before towing, you should consult with a competent towing outfit about safety recommendations.

## Call for help after an accident

### Emergency call numbers



EUROPE / INDIA	112
USA / CANADA	911
CHINA / JAPAN	119
NEPAL	101
IRAN	112
AUSTRALIA	000
NEW ZEALAND	111

### Help needed?

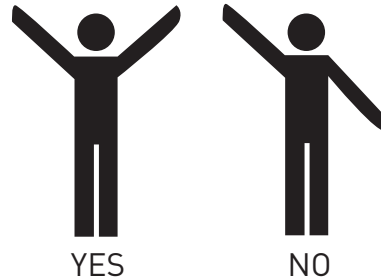

### Flashlight SOS :



## Harness cleaning and maintenance

It is a good idea to clean your harness from time to time. We recommend using a brush and soft solvents only ( soap or mild cleaning agents ). Rinse thoroughly. Never use aggressive chemicals such as strong solvents which could be harmful to the harness's fabric, webbings, stitching and weaken its integrity.

The zip fasteners should be lubricated from time to time, using a silicon spray.

If you regularly use your harness in a dusty environment ( dirt, sand, etc... ), we advise you to regularly check and maintain your carabiners and buckles : clean them with a mild detergent, then blow dry them fully but **DO NOT LUBRICATE !**

Prior to using them, conduct a thorough carabiners and buckles checkup to insure their full functionality.

If you use your harness in a marine/sandy/salty environment, pay particular attention to your gear and follow a rigorous care/maintenance routine.

## Storage and transport

When not in use, your harness should be stored inside your paragliding backpack, in a dry, cool and clean place, protected from UV exposure. If your harness is wet, please dry it thoroughly before storing.

For transport, protect the harness from any mechanical or UV deterioration (use a bag). Please avoid long transports in wet conditions.

## Life span



Once every two (2) years, a thorough harness inspection must be conducted :

- Webbing wear and tear (no excessive wear, no rip beginning, no unwanted folds)
- Buckles and carabiners ( functionality, wear and tear ).



The threads and fabric used for the manufacturing of the LOUSTIC 2 were specifically selected for their quality and resilience levels. However, in particular instances such as long term UV exposure, abrasion, contact with damaging chemicals, general wear and tear, the harness will need to be inspected at a professional certified repair facility. Safety comes first!



Supair advice to replace the carabiners and spreader bars every 5 years or after 500 hours of use.  
The self-locking carabiners are NEVER to be used for any activities other than paragliding.



## Repair

In spite of using the highest quality products to manufacture the LOUSTIC 2, it is possible for your harness to deteriorate through general use. If showing any sign of wear and tear, it should be sent for inspection and/or repairs at a professional certified facility.



SUPAIR now offers an extended warranty period reaching beyond the product standard protection plan against manufacturing defects. Please contact us either by telephone or by e-mail [sav@supair.com](mailto:sav@supair.com) in order to receive a quotation..

## Hardware & Parts

- Self-locking zicral 30mm carabiners (référence : MAILCOMOUS 30)
- Polypropylene seat plate ( LS2 : MPPL036 )

## Materials

Fabrics	Webbings	Seat Plate
N/210D 3line Honey Comb	Polyester 25 mm (1250 daN)	KD2 Polypropylène
Robic New Lite	Polyamide 15 mm	
Stretch Aquatech		

## Recycling

We have minimized our manufacturing footprint by carefully selecting environmentally friendly materials; most of our components are recyclable.

If you estimate that your LOUSTIC 2 has reached the end of its life span, you can separate plastics from metals and recycle them according to your community rules in effect. As for the fabric itself, contact your local authorities to find out how to proceed to discard it.

## WARRANTY

SUPAIR takes the greatest care in its products design and manufacturing and hence offers a five (5) year limited warranty from the date of purchase against manufacturing defects or flaws occurring during normal use. Any damage or degradation resulting from incorrect or abusive use, abnormal exposure to aggressive factors, including, but not limited to; high temperature, intense sun exposure, high humidity etc, will invalidate this warranty.

## DISCLAIMER



Paragliding is an activity requiring specific skills and sound judgement. Learn how to fly within the environment of a certified paragliding school. Carry an insurance policy with you in addition to your pilot certification. Always mind and gauge your personal skills relative to the elements you want to be flying in. Better be safe than sorry ! SUPAIR can not be held responsible for your paragliding decisions or activities.



**This SUPAIR product has been designed exclusively for paragliding. Any other activity such as skydiving or BASE jumping is absolutely forbidden.**

## PILOT'S GEAR



It is essential for you to wear a suitable head protection ( certified paragliding helmet ), boots and right clothing for the activity. Moreover, carrying a reserve parachute connected to your harness in flight is highly recommend.

This page will help you keep record of your LOUSTIC 2 scheduled maintenance.

Purchase date	
Owner's name :	
Name and stamp of the shop :	

<input type="checkbox"/> Care	
<input type="checkbox"/> Resale	
Date	
Workshop's name/ Buyer's name	

<input type="checkbox"/> Care	
<input type="checkbox"/> Resale	
Date	
Workshop's name/ Buyer's name	

<input type="checkbox"/> Care	
<input type="checkbox"/> Resale	
Date	
Workshop's name/ Buyer's name	

<input type="checkbox"/> Care	
<input type="checkbox"/> Resale	
Date	
Workshop's name/ Buyer's name	



SUPAIR-SAS  
Parc Altaïs  
34 rue Adrastée  
74650 Chavanod, Annecy  
FRANCE

[info@supair.com](mailto:info@supair.com)  
+33 4 50 45 75 29

RCS 387956790

■ ■ DESIGNED  
■ ■ IN ANNECY

 100% MADE  
IN EUROPE