



ACCESS 2 BUMP

User's manual

SUPAIR SAS
PARC ALTAÏS
34 RUE ADRASTÉE
74650 ANNECY CHAVANOD
FRANCE

RCS 387956790

Revision index : 02/04/2020



Thank you for choosing the ACCESS2 BUMP. We are glad to be able to share our common paragliding passion with you.

SUPAIR has been designing, producing and selling free flying equipment since 1984. By choosing a SUPAIR product you benefit from almost thirty years of expertise, innovation and listening. This is also our philosophy : working endlessly to develop better products and to maintain a high quality production.

We hope you will find this user's manual comprehensive, explicit and hopefully enjoyable as well. We advise you to read it carefully.

You will find the latest up to date information about this product on our website **www.supair.com**.

If you have any further questions, feel free to ask one of our retailers for answers. And naturally, the entire SUPAIR team is at your disposal on **info@supair.com**.

We wish you many safe enjoyable flying hours, and happy landings

Team SUPAIR

LIST OF CONTENTS

Introduction	4	Flight phases	29
Technical specifications	5	Pre-Flight check	29
Size choice	6	Take-off	29
Nomenclature	7	In flight	30
Harness Overview	8	Speed-bar use	30
Accessories assembly	9	Landing	30
Seat plate	9	Using the reserve parachute	31
Carabiners	9	Towing	31
Mini Bump	10	Mandatory controls	31
Bump	11	In case of an incident	32
Speed-bar	12	Maintenance	33
Installing the reserve parachute	13	Harness cleaning and maintenance	33
Reserve parachute characteristics	13	Storage and transport	33
POD reserve parachute handle connection	13	Product longevity	33
Parachute risers – harness connection	14	Repairs / spare parts	34
Place the risers inside the sleeve	16	Materials	34
Riser connection – reserve parachute	17	Recycling	34
Installing the reserve parachute in the container	18	Warranty	35
Locking the reserve parachute handle	23	Disclaimer	35
Gear packing and tips	24	Pilot's gear	35
Adjustments	25	Shock Absorber	36
The various adjustments	25	Service Book	37
Adjusting the harness	26		
Wing/harness Connection	27		
Inflight behavior	28		

Welcome to the world of paragliding according to SUPAIR, a world of shared passion.

The ACCESS 2 BUMP harness is designed for all for all flying enthusiasts no matter their level. The well thought-out design and choice of materials were guided by the same quality and durability objectives.

The ACCESS2 BUMP harness was certified EN 1651 : 2018 and LTF Nfl II 91/09. Indicating that it meets European and German safety requirements.

After reading this manual, we suggest you to check your harness in static hang-posts to adjust it before your first flight.

N.B : Three important icons will help you when reading this manual :



Advice



Caution !



Danger !!

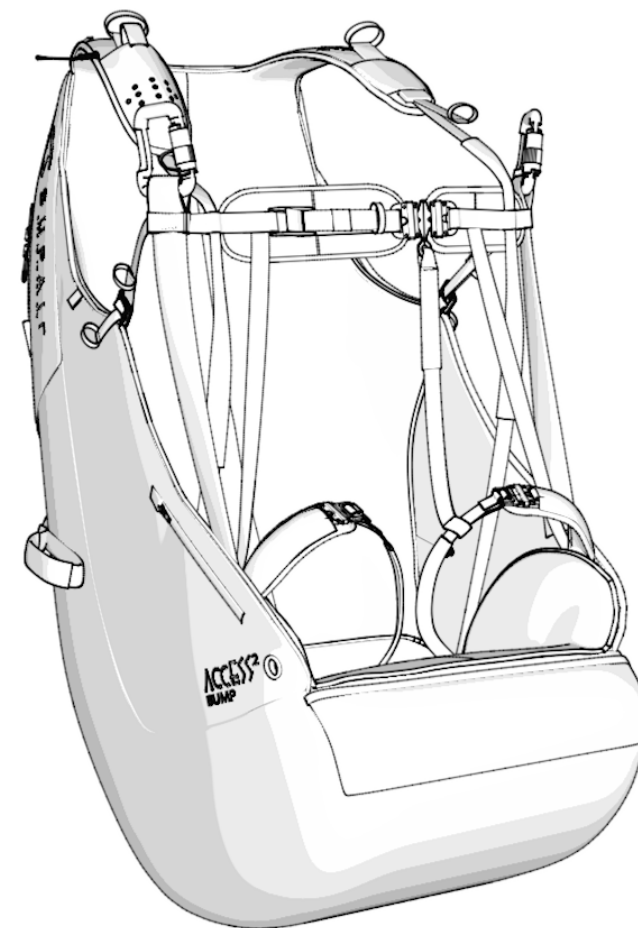

TECHNICAL SPECIFICATIONS

Harness size		S	M	L	XL
	Pilot size (cm)	155-170	170-185	180-195	190-205
	Pilot weight (mini - maxi) (kg)	55 - 75	65 - 85	70 - 100	80 - 120
	Harness weight (+ carabiners+speedbar)(kg)	4135	4225	4385	TBA
	Designed for	Paragliding only			
A	Back lenght (cm)	62	68	73	TBA
B	Backrest tilt adjustment (cm)	31	34	38	TBA
C	Seat length (cm)	46	48	53	TBA
D	Seat width (cm)	34	36	38	TBA
E	Carabiners height (cm)	43	45	47	TBA
F	Carabiners distance (cm)	36 - 46	36 - 46	36 - 49	TBA
	Impact damping system	BUMP			
	Certification	EN 1651 : 2018 - LTF Nfl II 91/09			
	Tandem (Pilot or Passenger)	/			
	Towing	Yes			
	Quick-out carabiners compatibility	Yes			
	Reserve parachute pocket volume (litre)	6			

- A** Back lenght
- D** Seat width
- B** Backrest tilt adjustment
- E** Carabiners height
- C** Seat length
- F** Carabiners distance

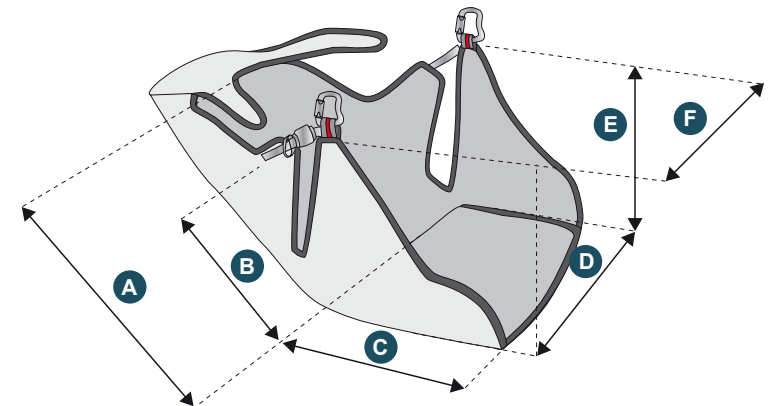

SIZE CHOICE

Choosing your harness size is important. You will find here below a height/weight table that will help you in your size choice. With its hammock architecture and its "lying flat" flying position, we advise you to try out the harness under a hanging device at one of our retailers in order to choose the correct size.

For a complete list of our retailers, please click here : www.supair.com

Size Weight	1m55	1m60	1m65	1m70	1m75	1m80	1m85	1m90	1m95	2m00	2m05
50											
55	S	S	S	S							
60	S	S	S	S							
65	S	S	S	S							
70	S	S	S		M	M					
75		S		M	M	M		L			
80			M	M	M		L	L			XL
85						L	L	L	L	XL	XL
90					L	L	L	L	L	XL	XL
95						L	L	L	L	XL	XL
100							L	L	L	XL	XL
105										XL	XL
110									XL	XL	XL
120									XL	XL	XL

 Preliminary test under hanging device

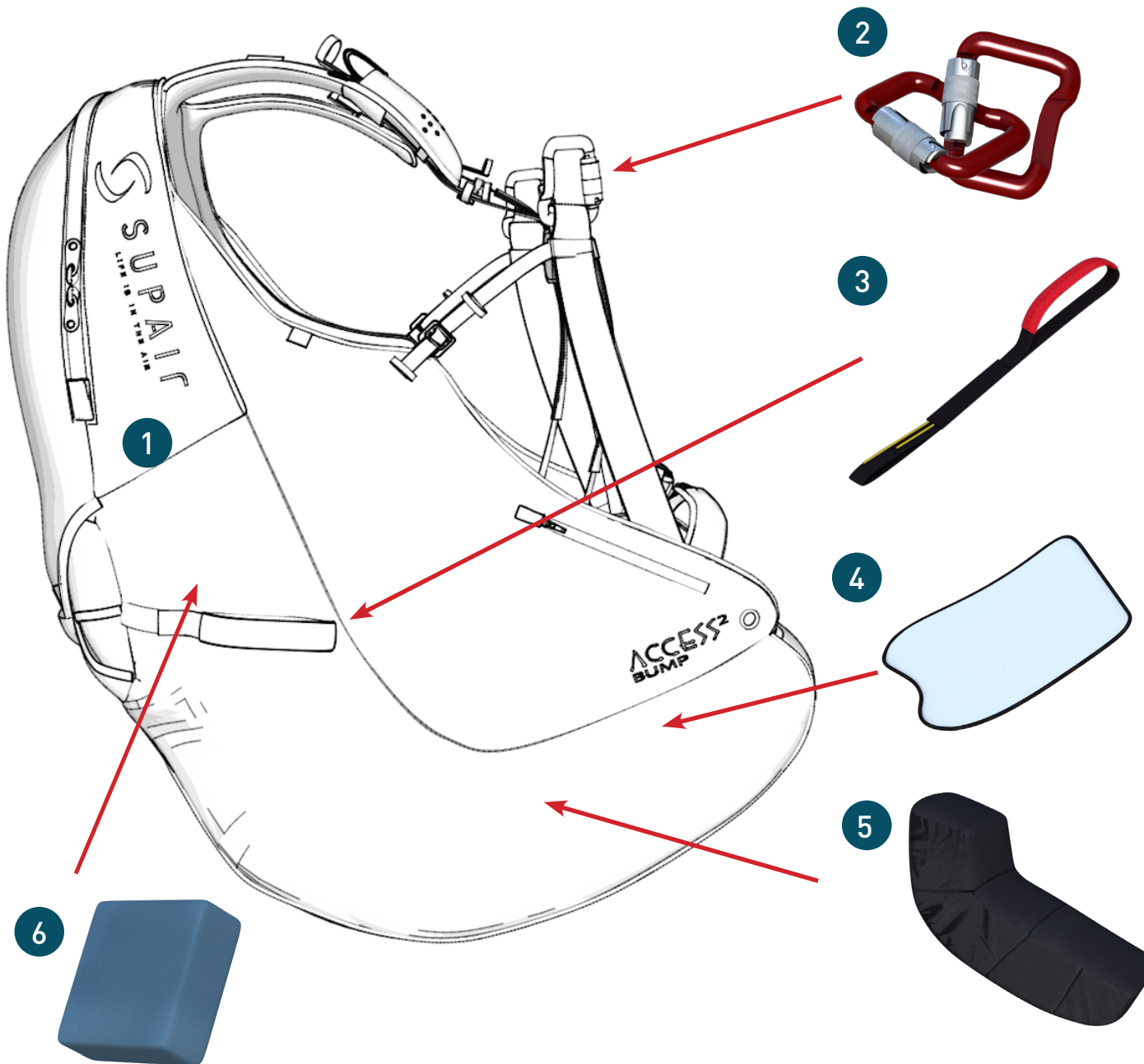

COMPONENTS LIST

- 1 Harness
- 2 2x 45 mm Zicral self-locking carabiners
- 3 « AC2 » reserve parachute handle
- 4 Polypropylene seat plate
- 5 Bump AB2
- 6 Mini Bump 2

Options

Adjustable accelerator FREESPEE
(ref: ACCELFREESPEE)

Solo DYNEEMA risers
(réf. : ELESOLODYNEEMA)

Carbon seat plate
(réf. : seat plate S 33*34cm: MPPL005)
(réf. : seat plate M 35*37cm: MPPL006)
(réf. : seat plate L: 37*37cm: MPPL007)

HARNES OVERVIEW

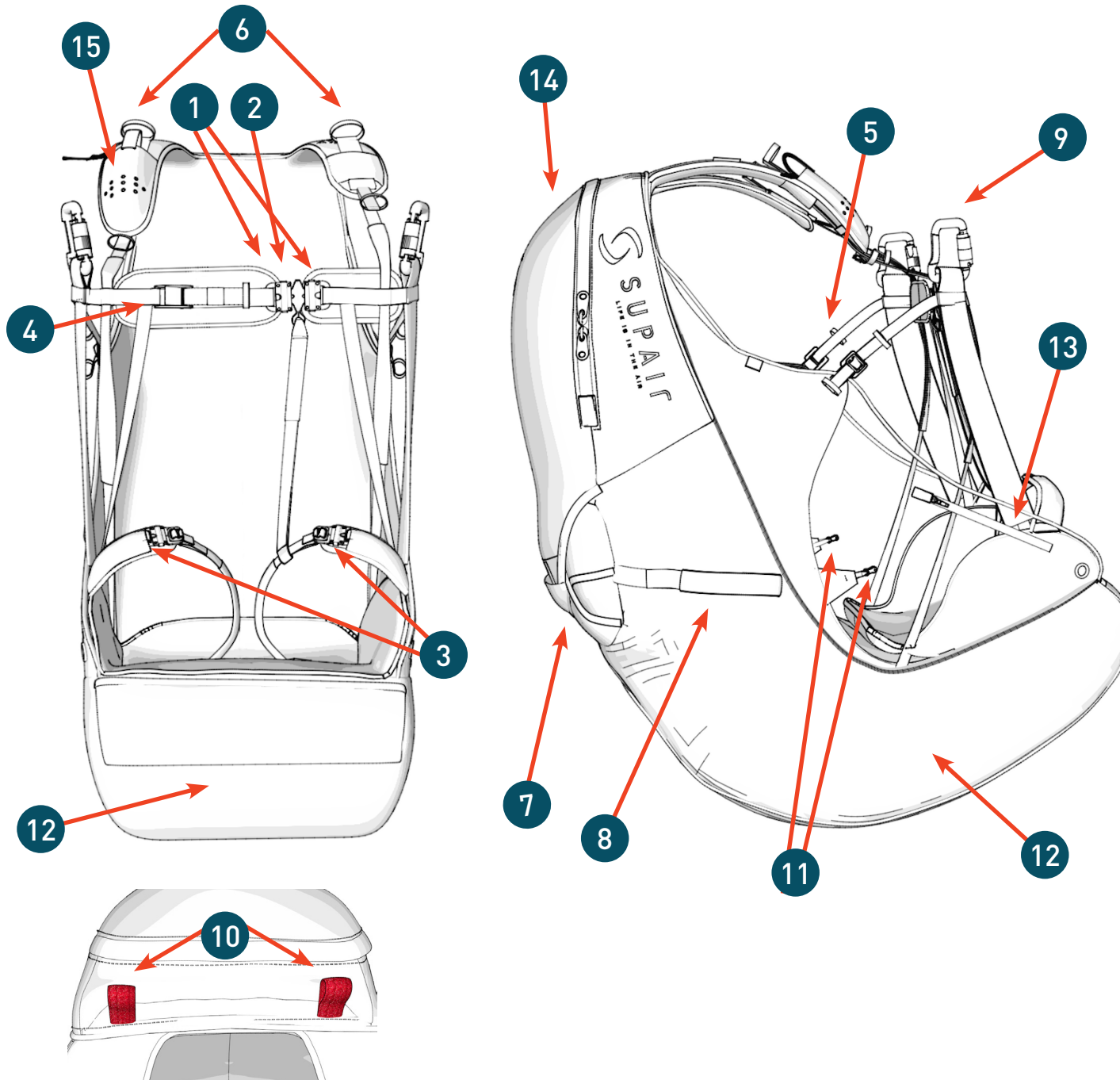

- 1 Chest strap with automatic buckles
- 2 Safe-T-bar
- 3 Leg Buckles
- 4 Chest strap adjustment
- 5 Backrest angle adjustment
- 6 Shoulder strap adjustment
- 7 Reserve parachute pocket
- 8 Reserve parachute handle
- 9 Points d'accroche principaux
- 10 Paragliding main hooking points
- 11 Pulleys For speedsystem
- 12 Bump
- 13 Small storage pocket
- 14 Back storage pocket
- 15 Radio pocket

ACCESSORIES ASSEMBLY

Carabiners

Compatible carabiners :

45 mm Self-locking zicral carabiners

Réf. : MAILCOMOUS45

Insert the carabiner through the main harness riser connection.

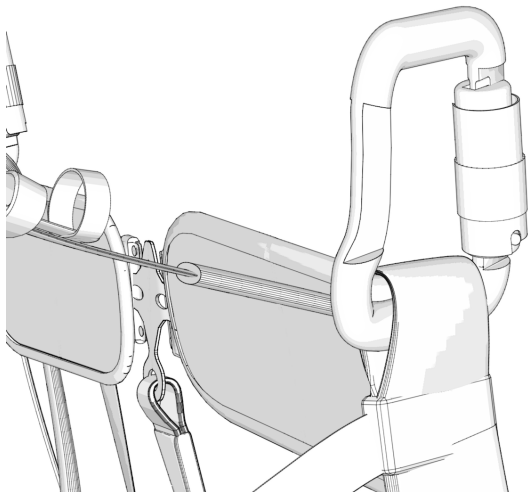
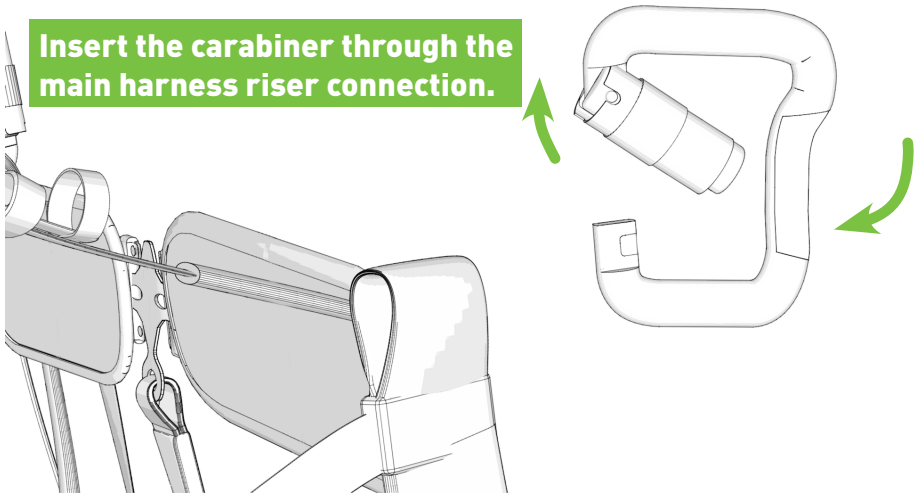

Seat plate

Polypropylene seat plate :

Size S Réf. : MPPL030

Size M Réf. : MPPL031

Size L Réf. : MPPL032

Size XL Réf. : MPPL033

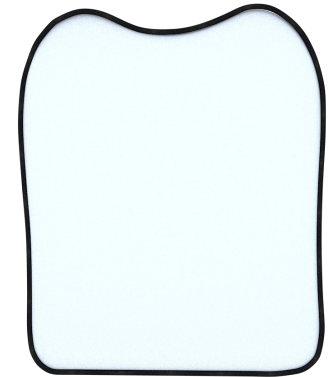

Installing the seatplate :

1. Open the velcro located under the rear side of the seat.
2. Slide the seat plate inside its housing and fasten the velcro.

Rear

Front

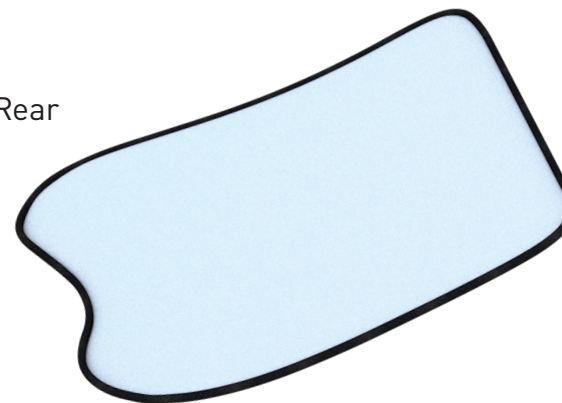

Flight direction →

ACCESSORIES ASSEMBLY

MINI BUMP 2

Compatible Mini Bump :

Mini Bump 2 Ref. : PROMINIBUMP2

Mini bump assembly :

1. Open the back storage pocket.
2. Open the zip located at the bottom of the back storage pocket, then you'll access to the mini bump's space
3. Slide the minibump in
4. Fasten the zip
5. Fasten the storage pocket

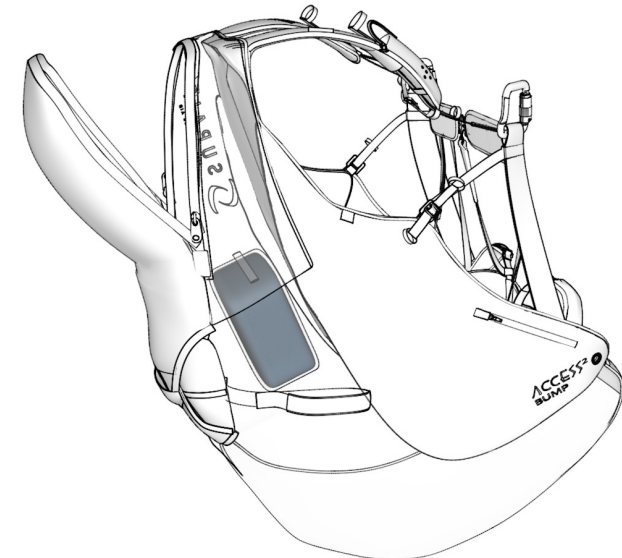
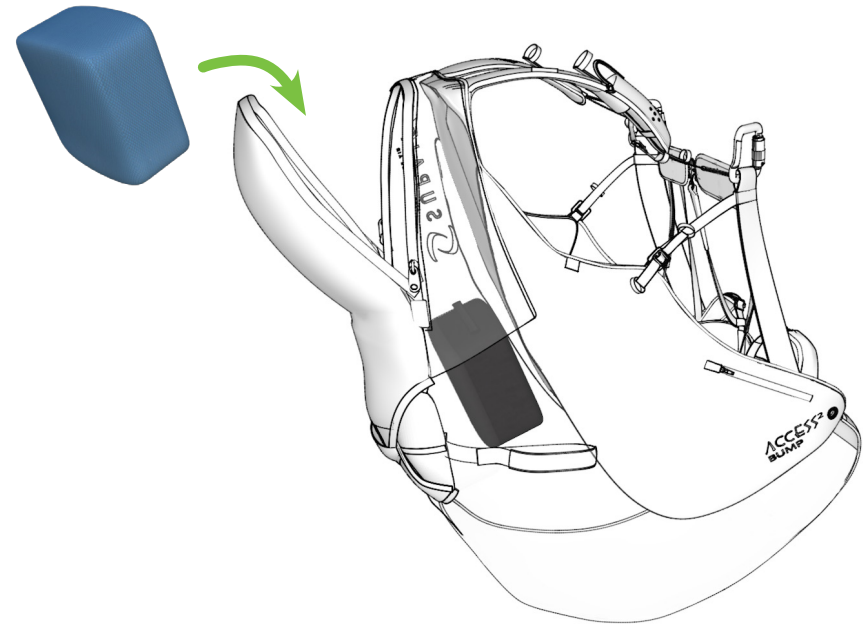

BUMPER AB2

Compatible Bumper :

Bumper Réf. : PROBUMPAB2

Bumpair assembly :

1. Open the zip of the storage situated under the seat, then you'll access to the bumpair space
2. Slide the bumpair in
3. Fasten the zip.

ACCESSORIES ASSEMBLY

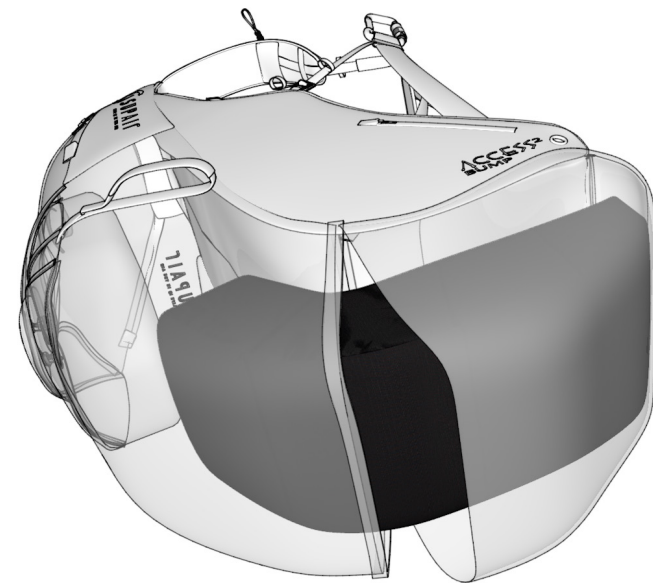
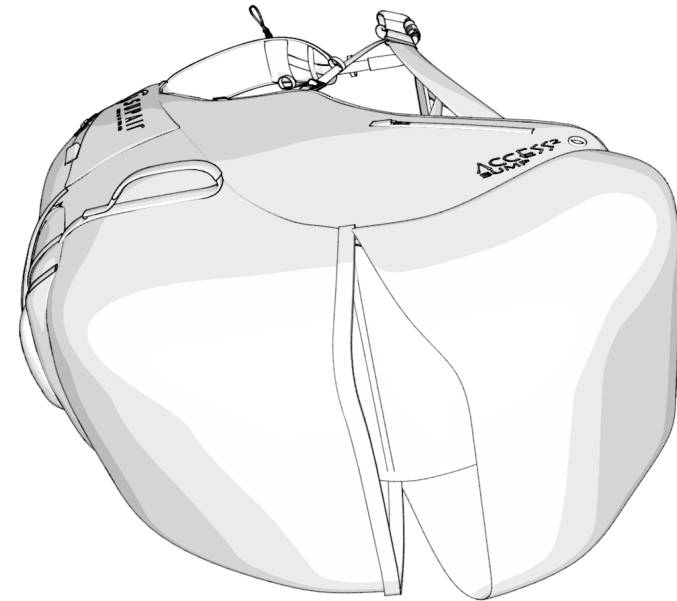

Speed-bar system (option)

Compatible speed-bar :

STANDARD double stage speed-bar

(Réf. : ACCELSOUPLE)

Speed-bar 2B light

(ref: ACCELSOUPLELIGHT)

Adjustable speed-bar FREESPEE

(ref: ACCELFREESPEE)

Speedbar assembly :

Regarding either side of the harness: :

- 1 Pull the line through the speed-bar line guide located at the front corner of the seat plate.
- 2 Pull the line up and through the speed-bar pulley.
- 3 Push the speed-bar line in the Speed-bar opening.
- 4 Finally, attach a hook to the cord before connecting it to the glider's speed-bar.

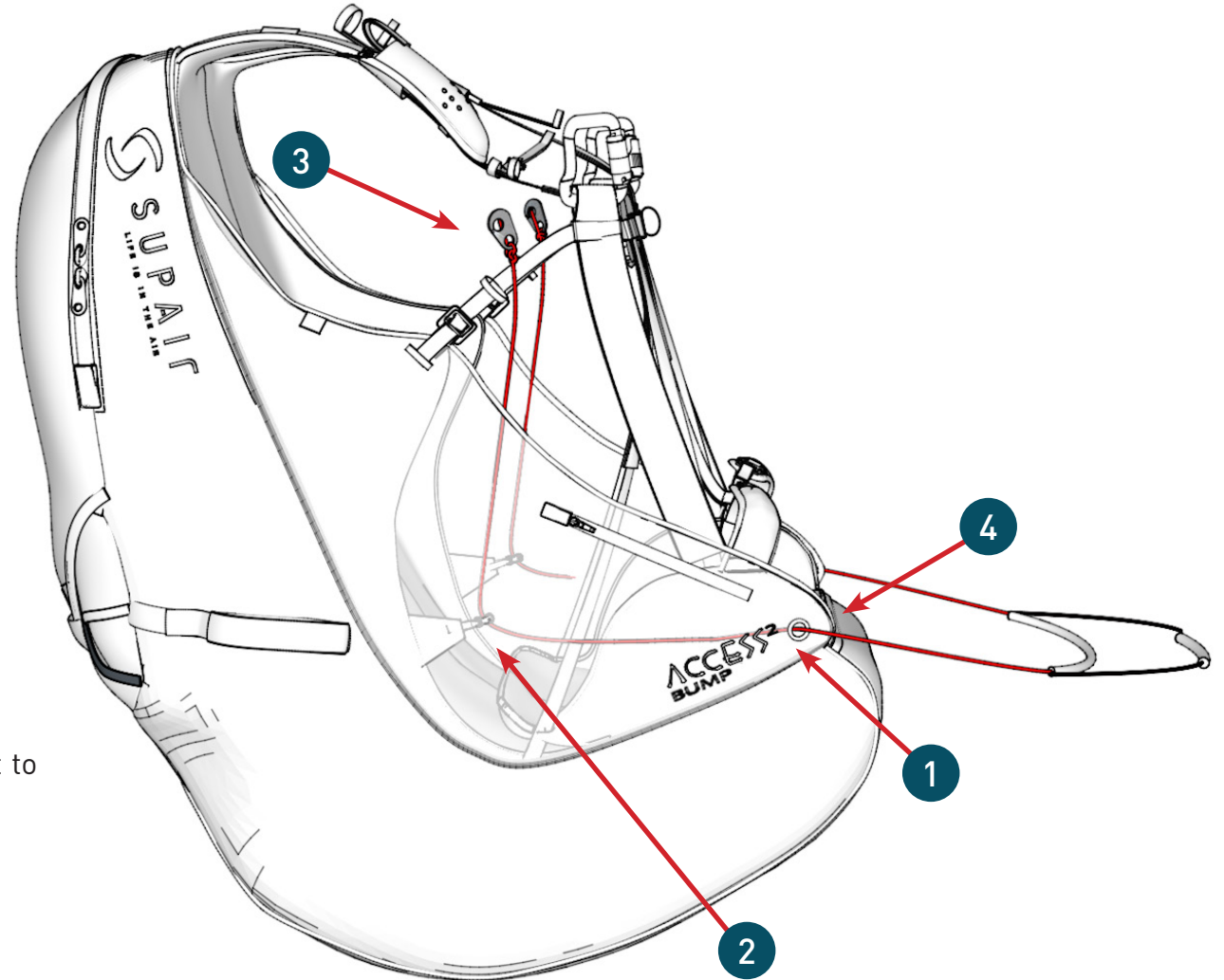

Simulate the speed-bar/accelerator's functionality by sliding the cord back and forth.

INSTALLING THE RESERVE PARACHUTE



Thank you for reading the following carefully ! We recommend for the initial rescue parachute assembly and installation to be made by a qualified professional.

Reserve parachute folding and installation inside the harness must conform to the specific guidelines found in this manual.

Rescue parachute pocket characteristics

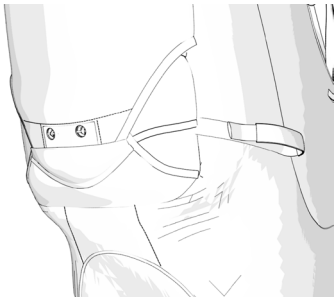

- Flaps fastened with a cable
- Volume 4 to 6 liters
- Adapted to the reserve parachutes SU-PAIR, START, SHINE, FLUID and FLUID LIGHT as well as other rescue solo models.

ACCESS 2 BUMP Size S and M			
Compatible parachutes	S	M	L
SHINE	✓	✓	✓
START		✓	✓
FLUID	✓	✓	✓
FLUID LIGHT	✓	✓	✓

ACCESS 2 BUMP size L			
Compatible parachutes	S	M	L
SHINE	✓	✓	✓
START		✓	✓
FLUID	✓	✓	✓
FLUID LIGHT	✓	✓	✓

Connecting the handle to the POD

- 1 Fasten the reserve parachute handle bridle to the external pod loop via a Lark's head knot connection.

If you have a large reserve parachute, and feel a slight resistance during the pod extraction hang-test, connect the reserve parachute handle to the side loop instead.

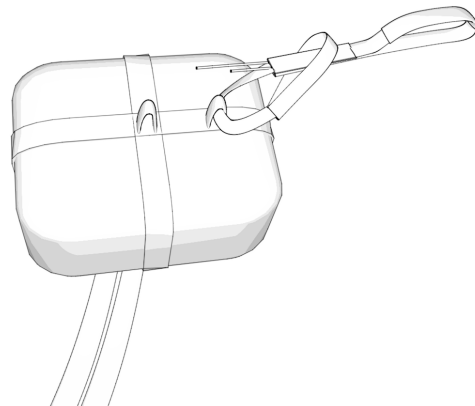

- 2 Tighten the handle/POD connection securely.



INSTALLING THE RESERVE PARACHUTE

Riser/Harness connection

>> Access to the reserve parachute connection points.

First, open the riser guiding sleeve all the way from top to bottom to access the reserve parachute connection loops. Once the riser guiding sleeve is fully opened, the zipper tab must be located on the same side of the reserve parachute pocket.



We recommend using "split" risers to guaranty a clean reserve parachute deployment.

A Fastening the risers to the harness via a Lark's head knot connection.

1 Attach each riser to the shoulder attachment points by making a Lark's knot (loop to loop connection). Use the largest bridle loop ends.

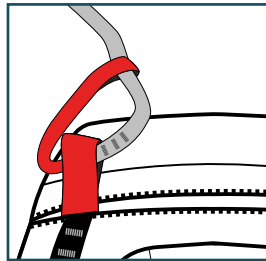

2 Assemble everything correctly. Make sure for the risers not to be longer than one another.

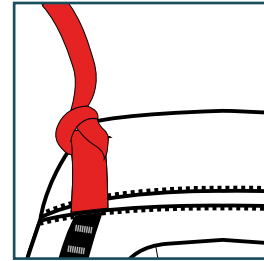

3 Tighten each connection securely.

B Fastening the risers to the harness with a set of 6mm square Maillons Rapides®

Take two 6mm square Maillons Rapides® and two toric elastic rings.

1 Open the 6mm mail- lon Rapide®

- Push the toric ring through the Maillon Rapide® and twist it.

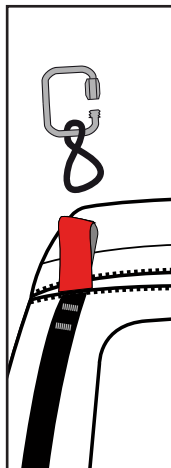

2 Push the bridle connecting point through the toric ring loop

- Push the Maillon Rapide® through the bridle connection loop.

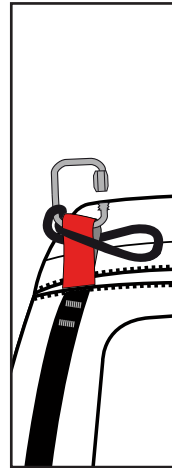

3 Give the toric ring a second twist

- Push the bridle through the Maillon Rapide®
- Make sure the riser stays in place.

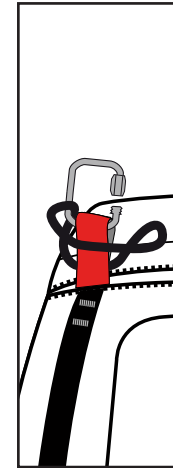

4 Close the mail- lon Rapide® by hand, then tighten using a set of pliers and making a 1/4 turn.

- Repeat the procedure with the second bridle connection loop.

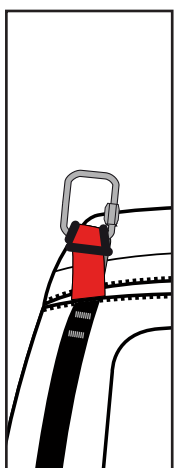

INSTALLING THE RESERVE PARACHUTE

Riser/Harness connection

Fastening the risers to the harness with a set of 6mm square Maillons Rapides®.

1

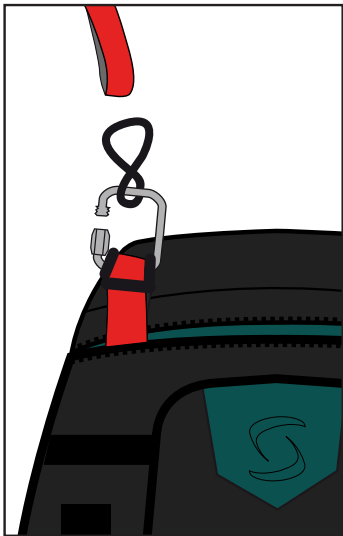

- Open the 6mm Maillon Rapide®
- Push the toric ring through the Maillon Rapide®
- Twist it

2

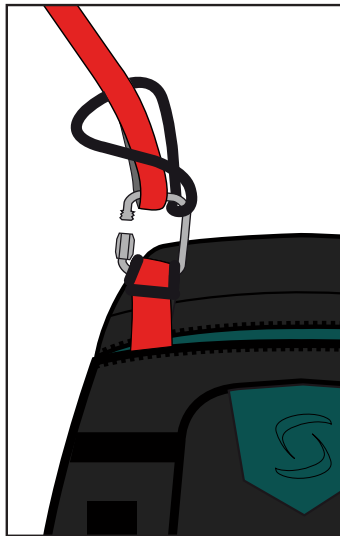

- Push the riser connecting point through the toric ring loop
- Push the riser in the 6mm Maillon Rapide®

3

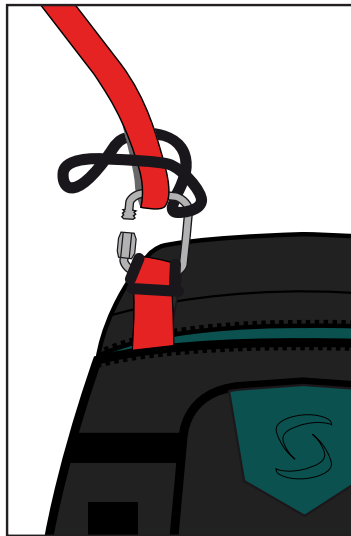

- Give the toric ring a second twist

4

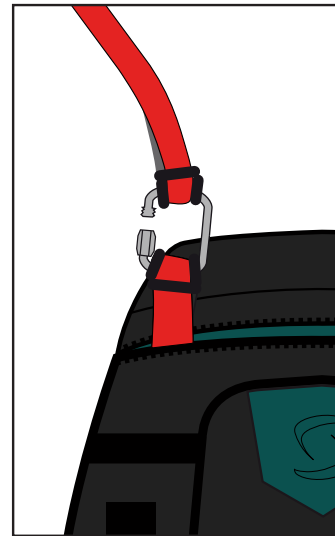

- Push the riser end loop through the Maillon Rapide®

5

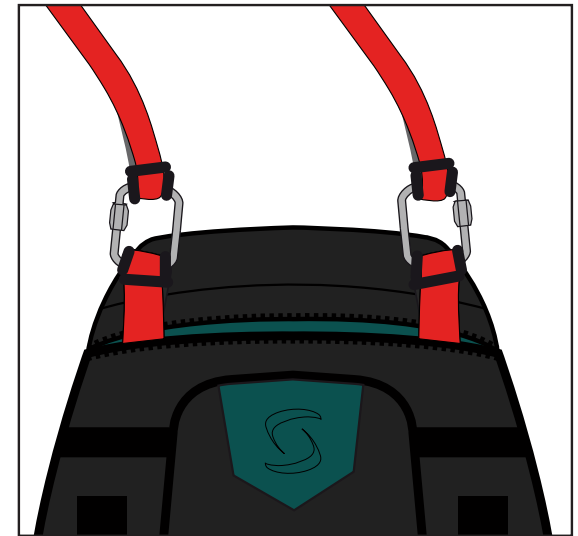

- Check that the risers do not move
- Close the Maillon Rapide® by hands and tighten with a 1/4 turn using set of pliers
- Repeat the procedure with the second riser

INSTALLING THE RESERVE PARACHUTE

Place the risers inside the sleeve

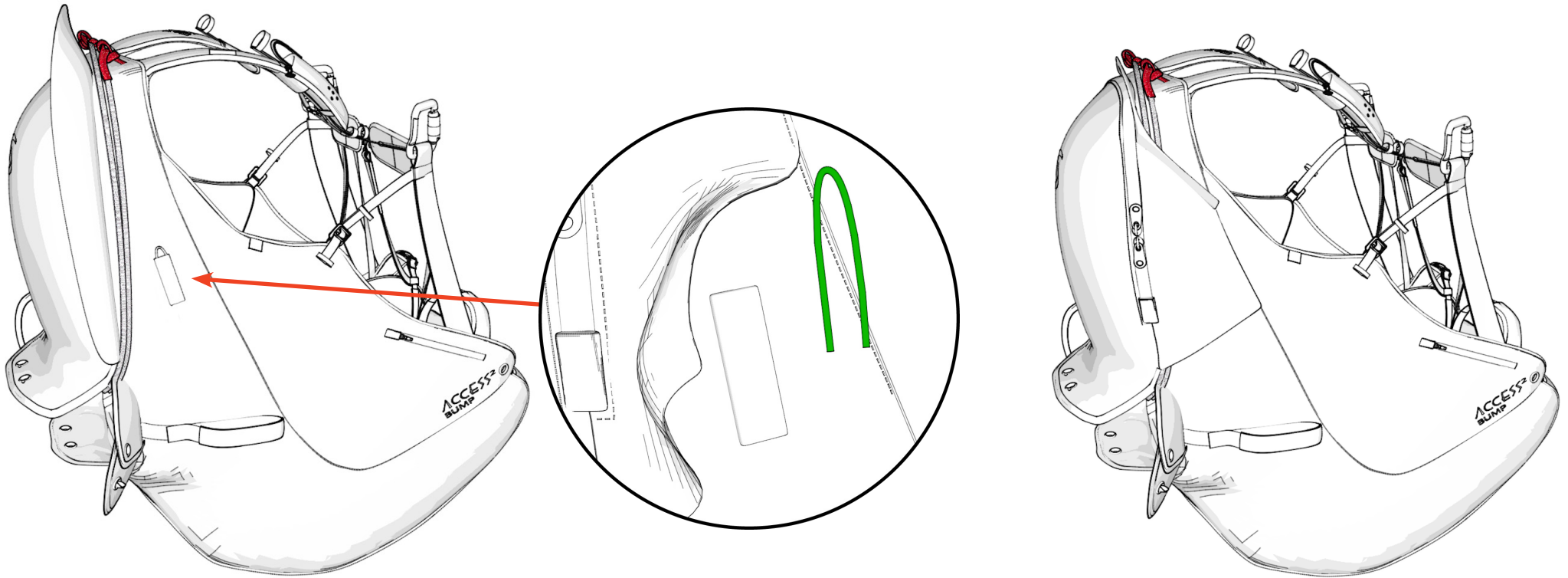

- 1 - Place the risers inside their guiding/protective sleeve connected alongside the harness.
 - Pull out the folding rod from its groove
 - Bring them out through the reserve parachute container

- 2 - Push the connection points inside the sleeve
 - Use the Velcro to close the sleeve until the left shoulder strap

INSTALLING THE RESERVE PARACHUTE

Reserve parachute/risers

One (1) square 7mm Maillon Rapide® will be needed + two (2) flexible toric rings.

1

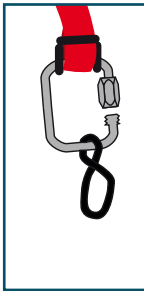

- Open the 7mm square Maillon Rapide®
- Push the maillon through the risers loops
- Push the maillon through the plastic ring
- Twist

2

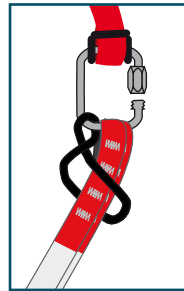

- Push the two riser ends through the toric ring loop.
- Push the maillon through the riser loop

3

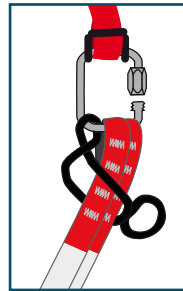

- Give a second twist to the plastic ring.
- Push the buckle through the maillon.

4

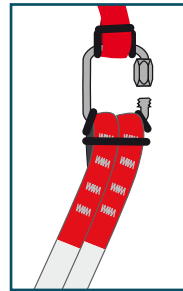

5

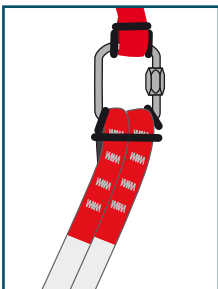

- Tidy up the assembly.
- Be certain for the riser end loops to be securely fastened.
- Close the Maillon Rapide® tightly by hand.
- Tighten using pliers and making a ¼ turn.

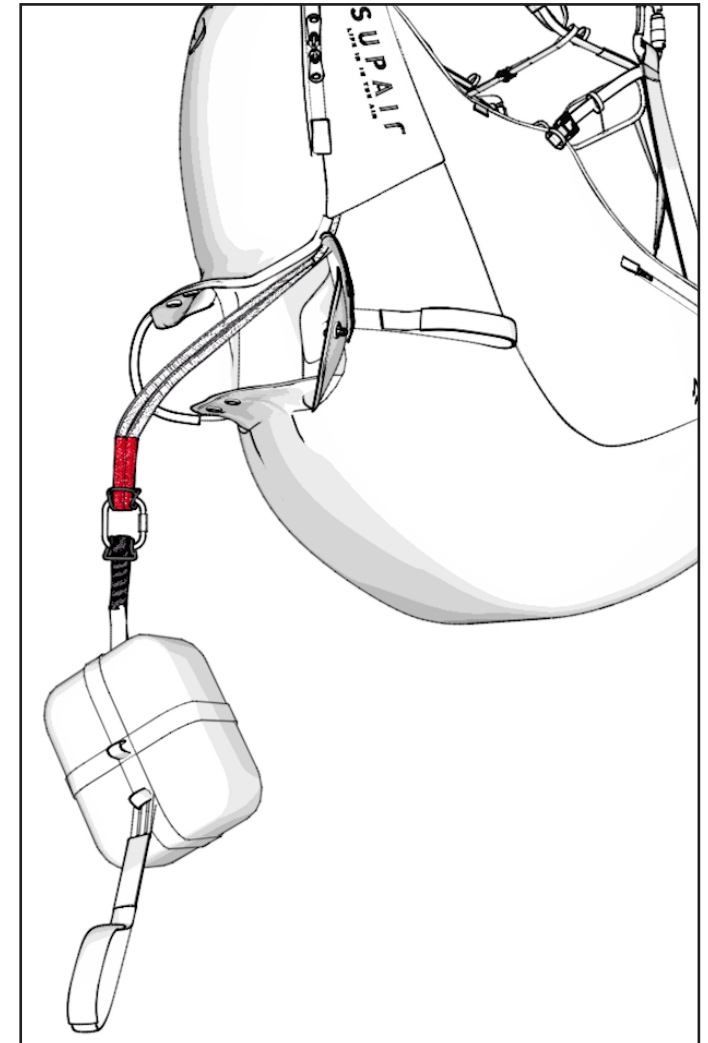

INSTALLING THE RESERVE PARACHUTE

Installing the reserve parachute in its container



Thank you for reading the following carefully ! We recommend for the initial rescue parachute assembly and installation to be made by a qualified professional.

Reserve parachute folding and installation inside the harness must conform to the specific guidelines found in this manual.

- 1 Place the reserve parachute inside the reserve parachute pocket with the handle on the right side and the risers on the bottom of the container

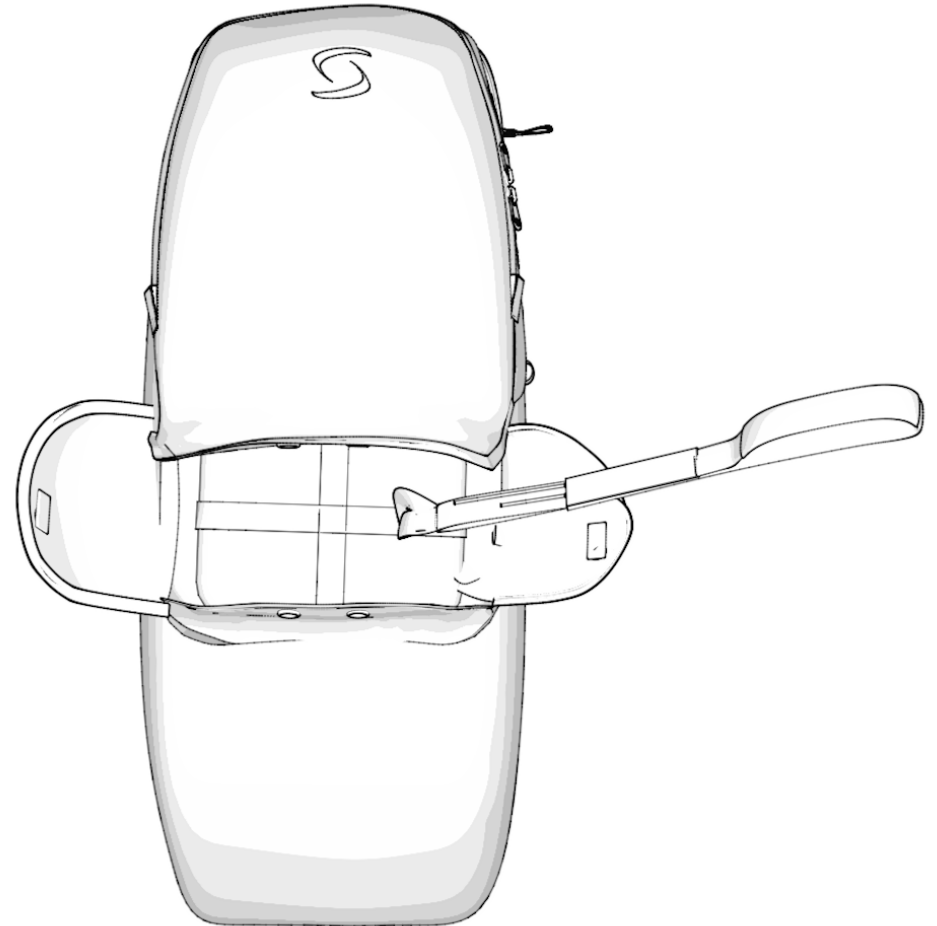

INSTALLING THE RESERVE PARACHUTE

Installing the reserve parachute in its container

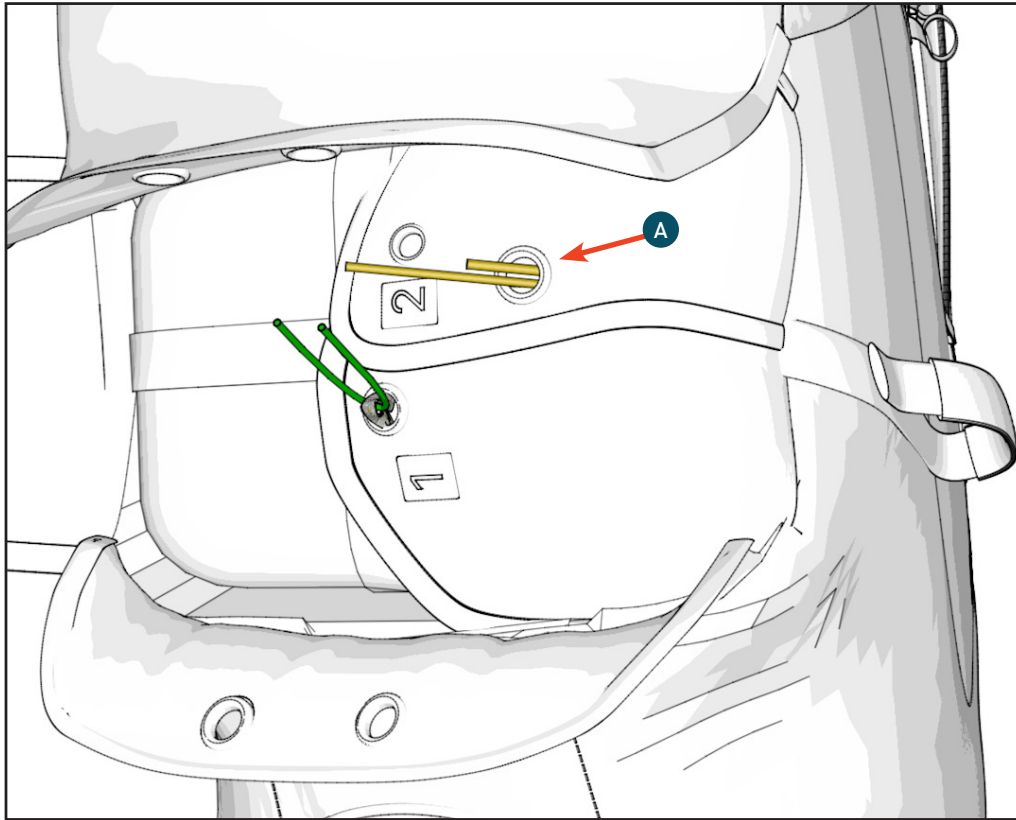

2

- The handle should run between the Flaps 1 and 2
- Pass the 2 handle's cable through the grommet A
- Pass the folding rod through the white lanyard loop number #1

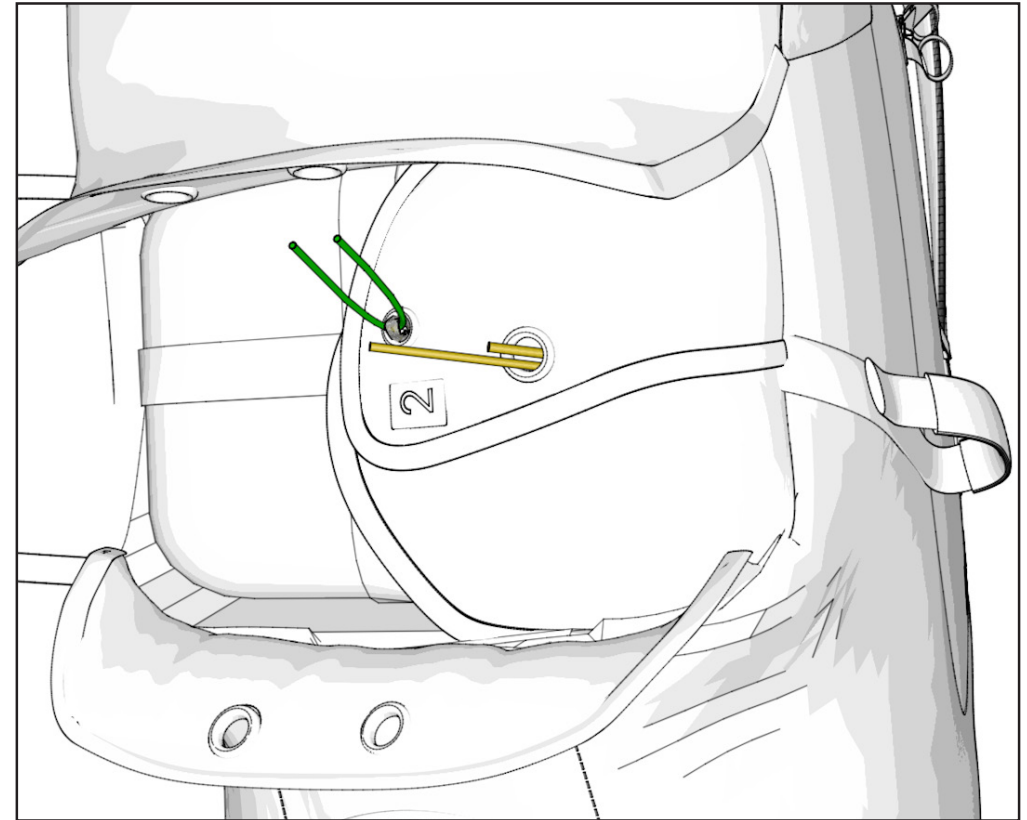

3

- Using the rod, pass the loop #1 through the grommet #2

INSTALLING THE RESERVE PARACHUTE

Installing the reserve parachute in its container

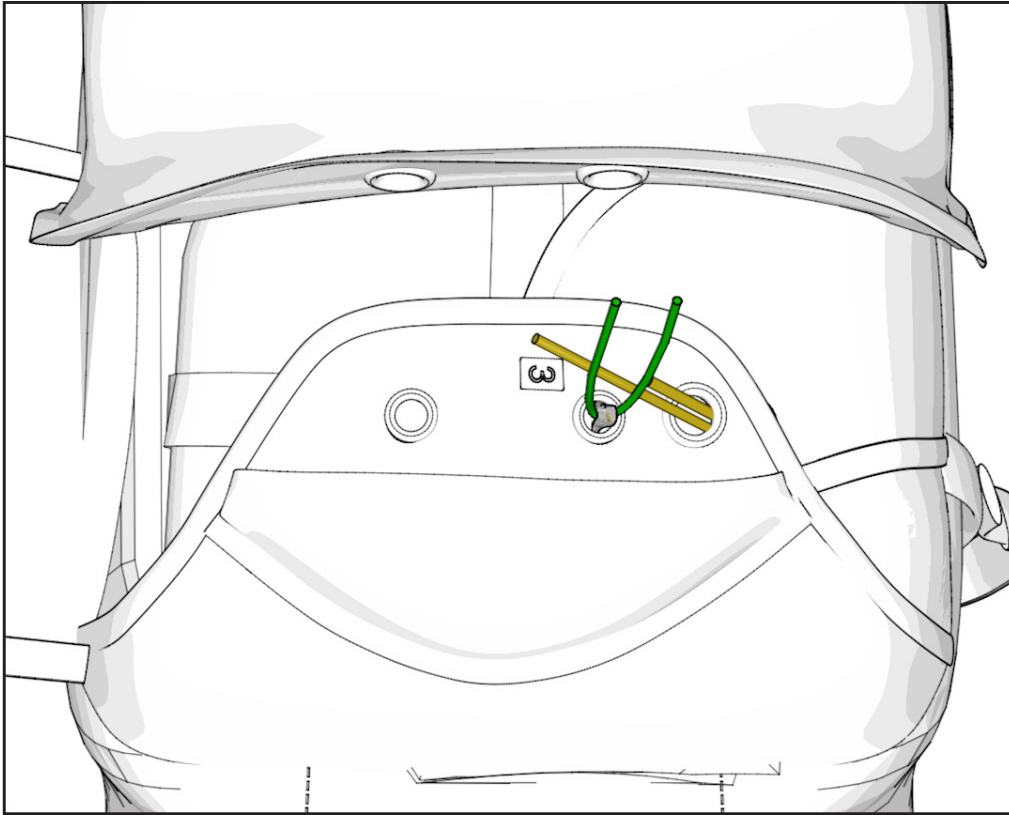

4

- Then through the gommel #3

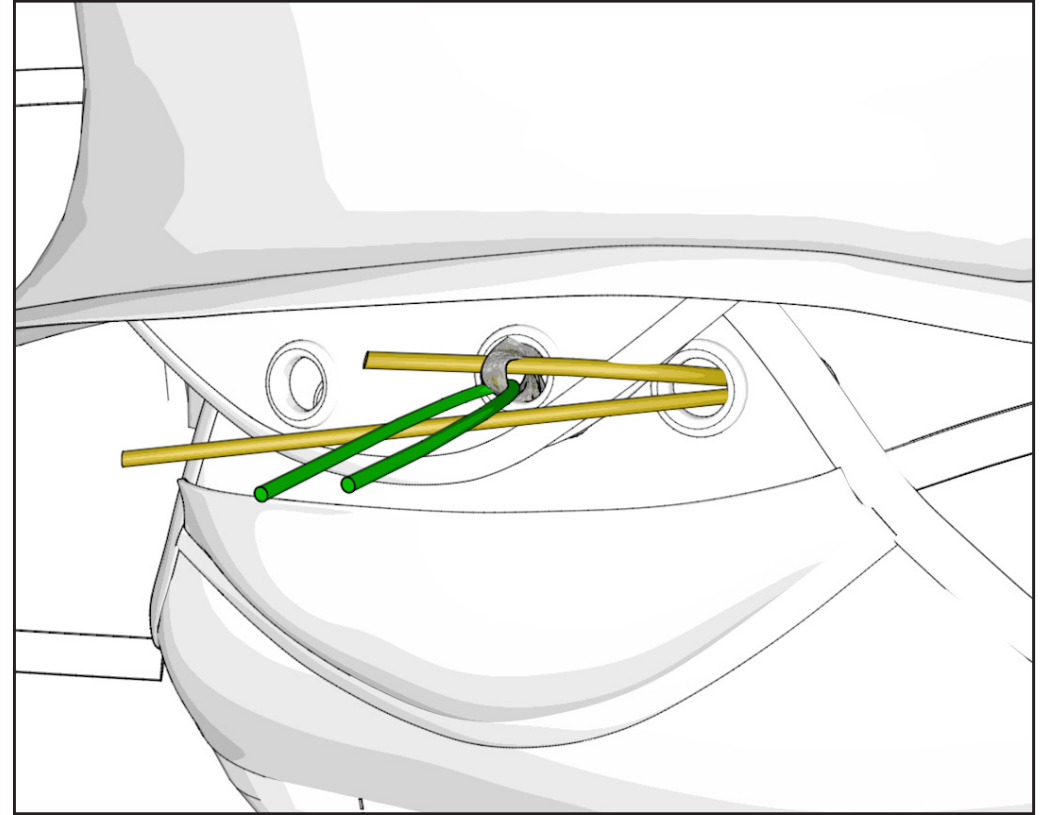

5

- Fix this closing passing the shorter handle's cable into the white loop #1

- Remove the folding rod

INSTALLING THE RESERVE PARACHUTE

Installing the reserve parachute in its container

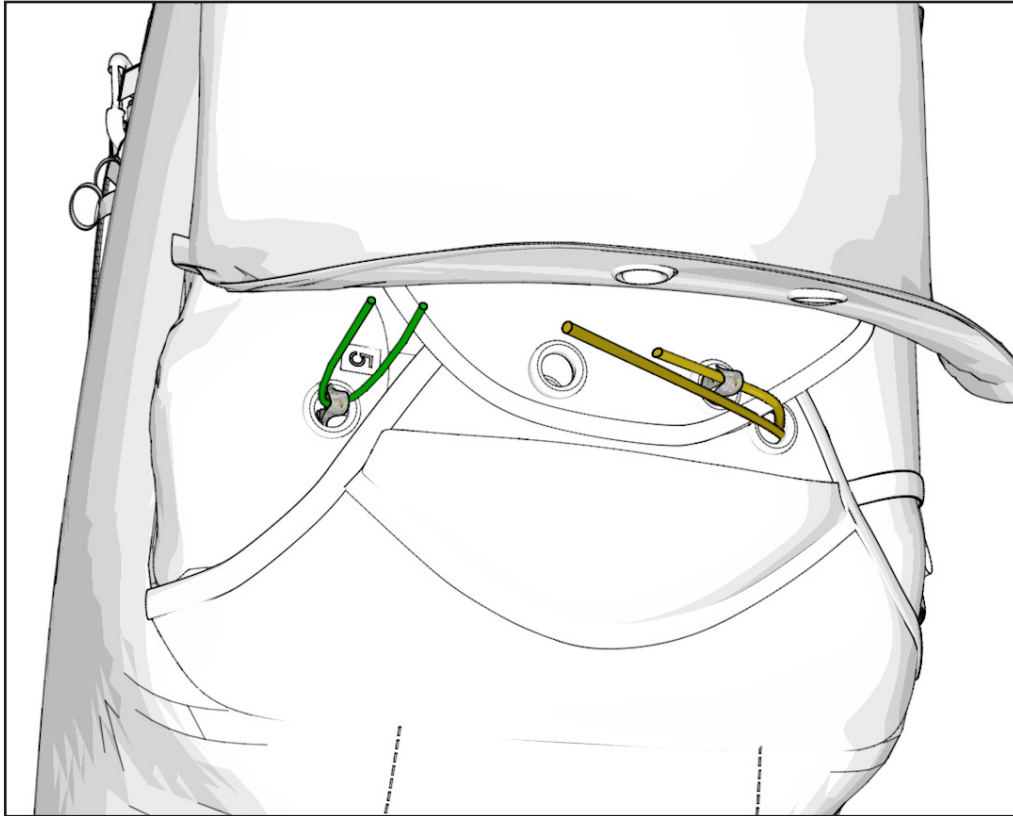

6

- Pass the folding rod through the white lanyard loop number #5

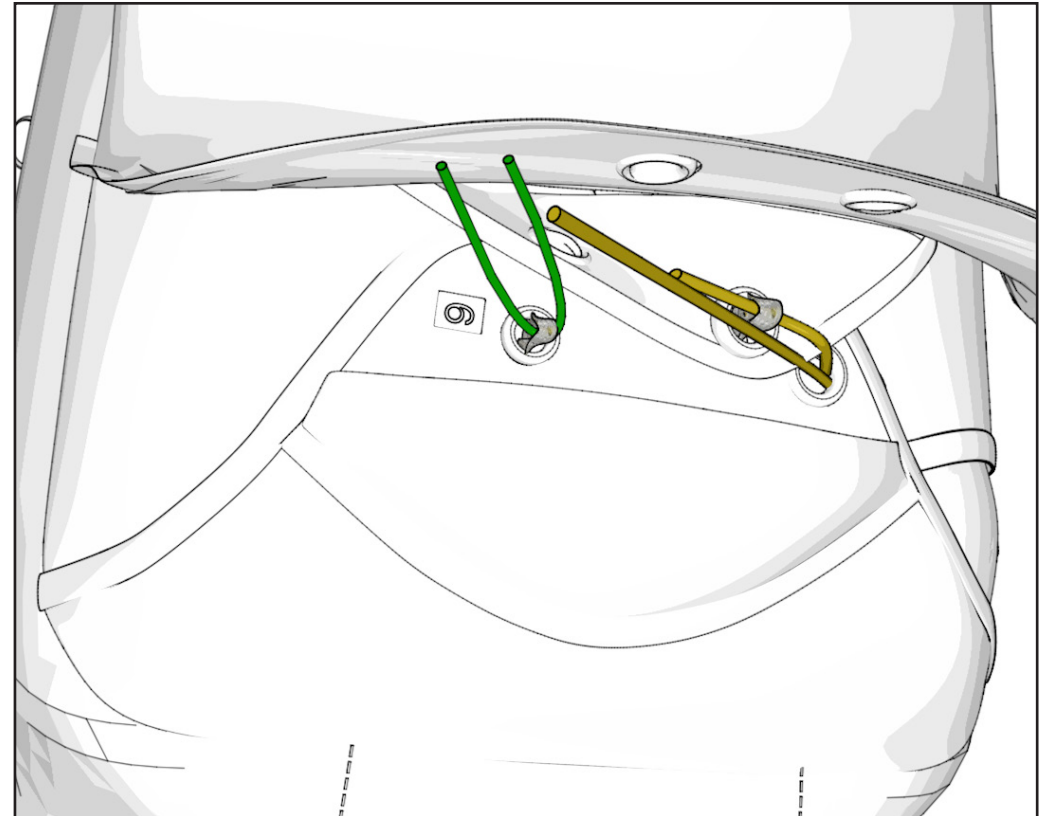

7

- Using the rod, pass the loop #5 through the grommet #6

INSTALLING THE RESERVE PARACHUTE

Installing the reserve parachute in its container

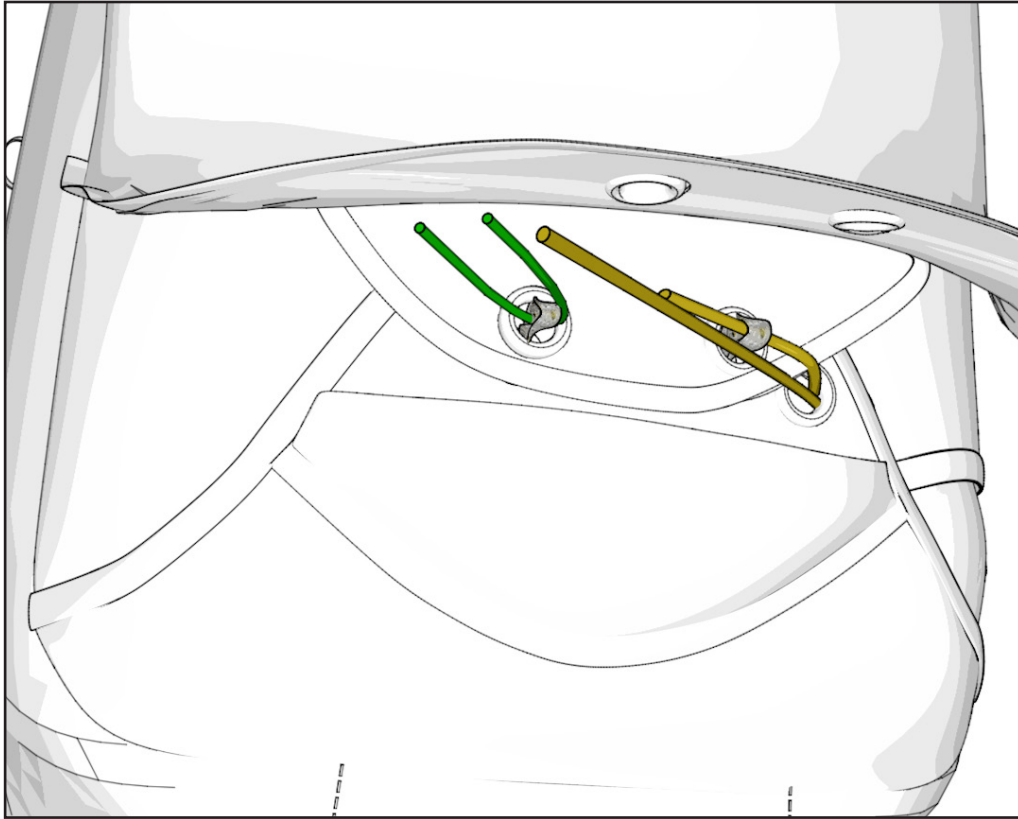

8

- Then through the gomet #7

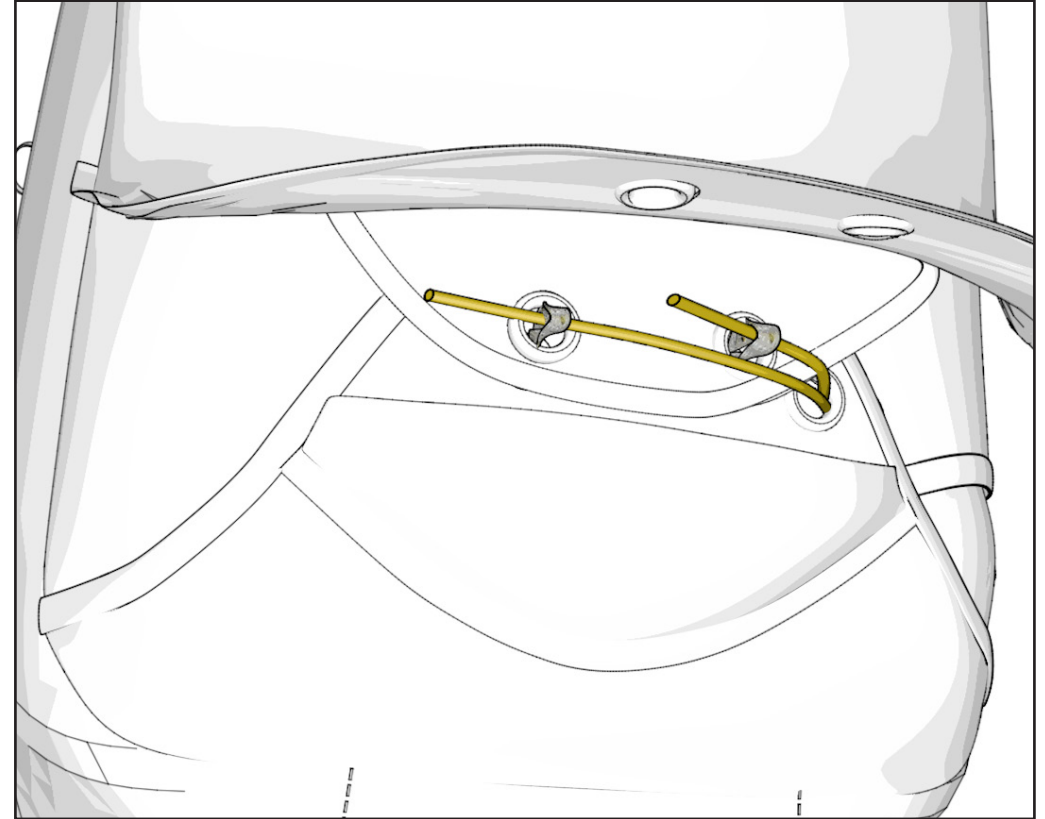

9

- Finalize this closing passing the longer handle's cable into the white loop #5. Then remove the folding rod.

INSTALLING THE RESERVE PARACHUTE

Locking the reserve parachute handle

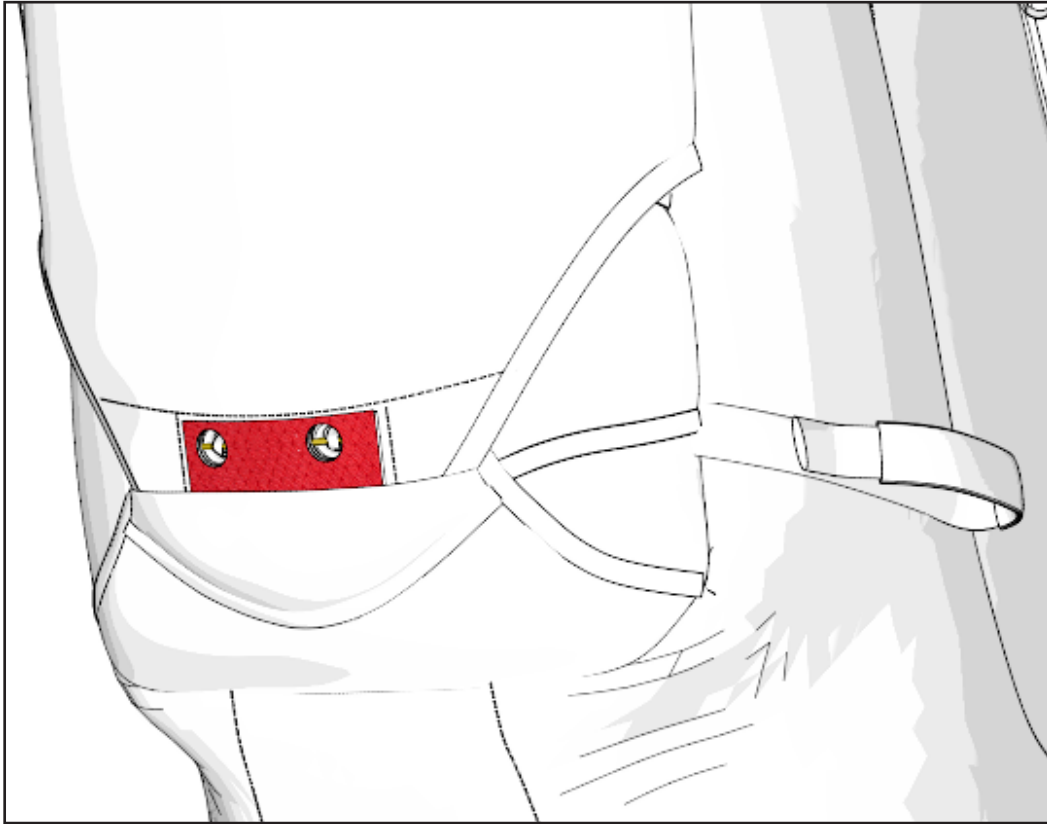

10

- Turn down the upper flap in its storage

Mandatory extraction test procedure



Check the completed installation during a hang-test.

Have the installation checked by a professional outfit.
Conduct an extraction test every six (6) months to assure proper system functionality.

Note :
Conducting and extraction test does not imply deploying the reserve parachute which will stay inside its POD.

PACKING AND TIPS

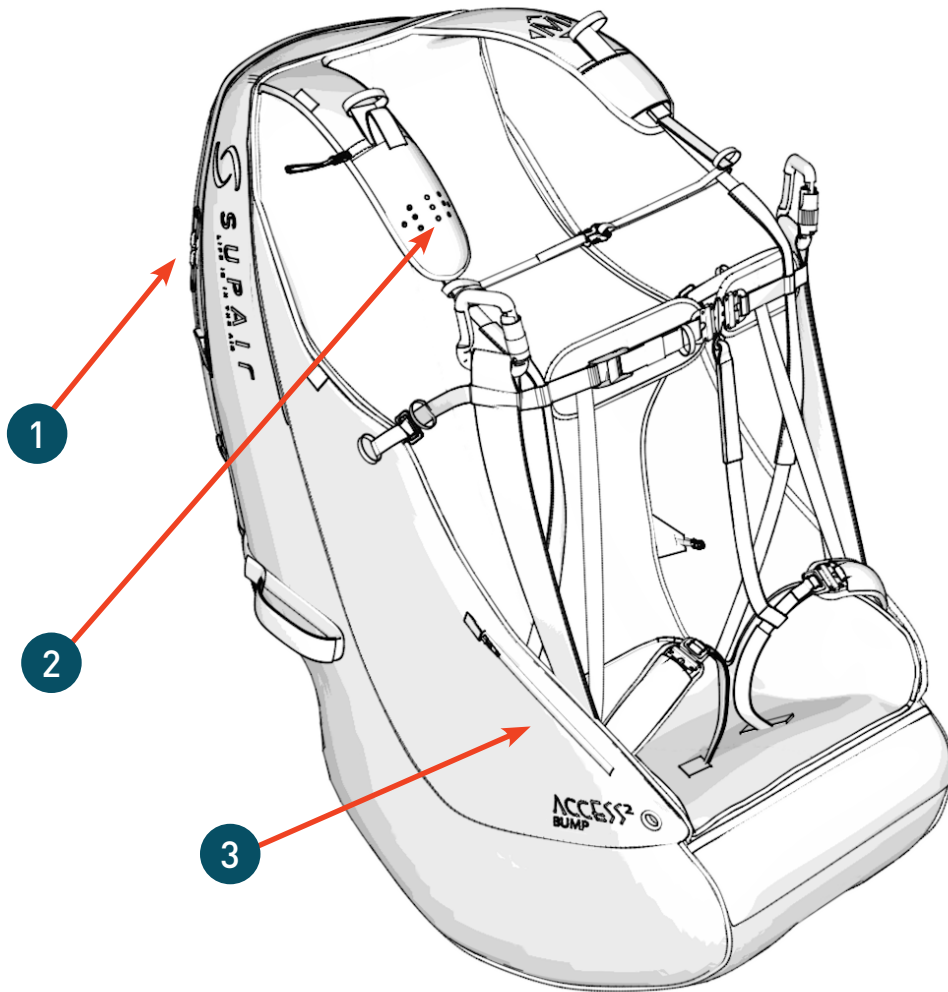

- 1 Back storage pocket
- 2 Radio pocket
- 3 Small storage pocket



Tips : we have color coded the various locking buckles to help with the installation sequence and prevent beginner pilots from making mistake during harness fastening. It will also help the instructor to quickly spot any error made by the student during the pre-flight check procedure.

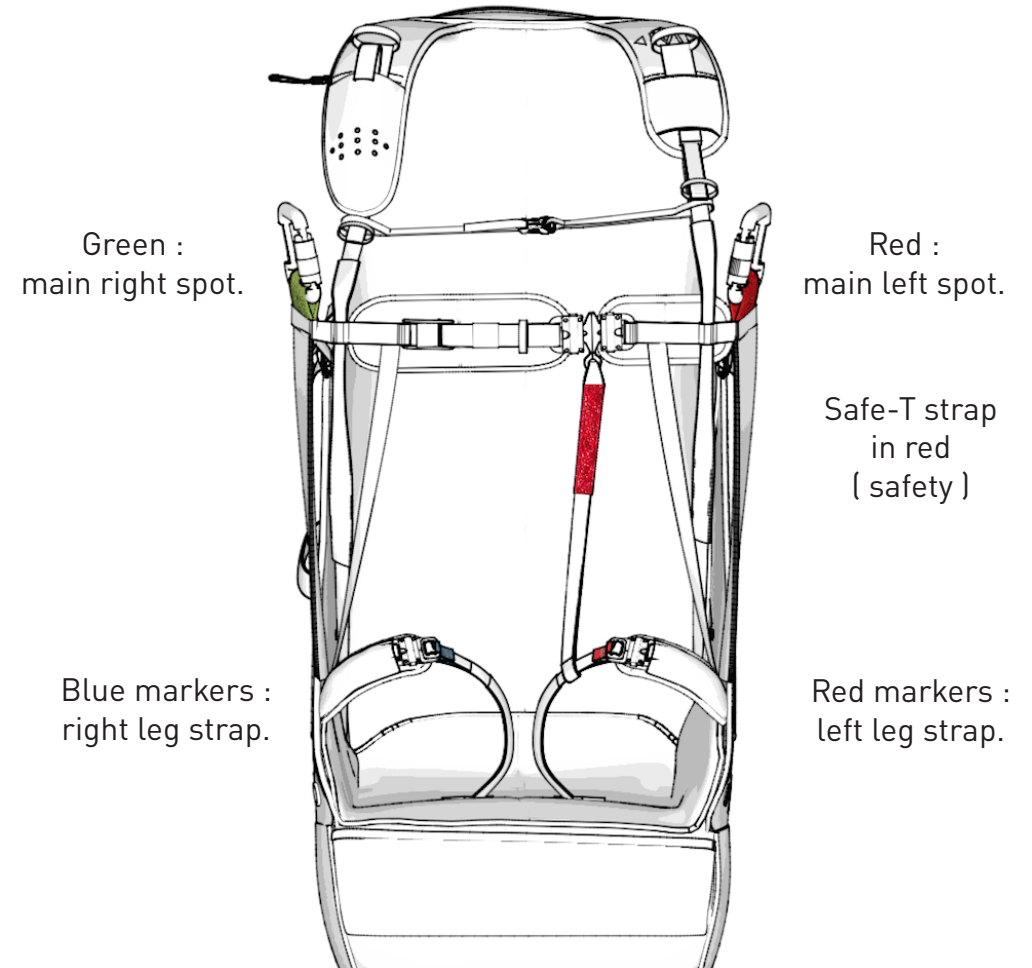

ADJUSTING THE HARNESS



Adjusting the harness prior each takeoff is vital.

The various adjustments.

- 1 Adjusting the chest strap
- 2 Adjusting the backrest
- 3 Adjusting the shoulder straps
- 4 Leg straps adjustment

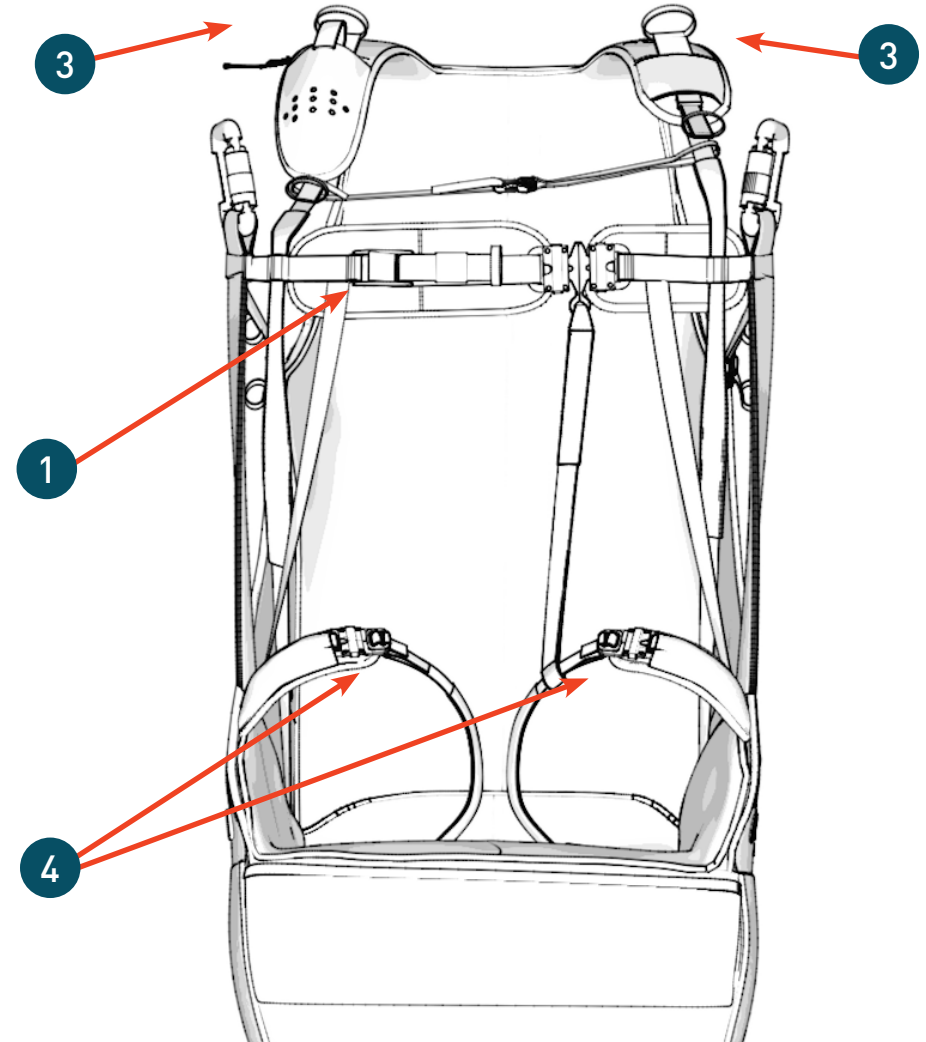
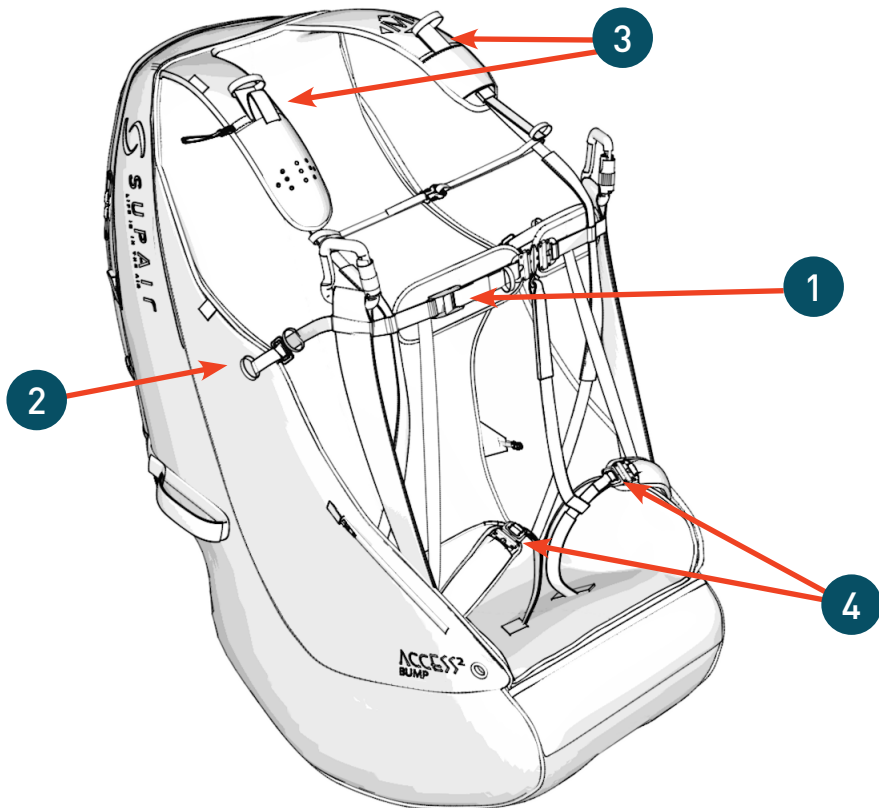

Adjusting the harness

Without strap tension, first adjust the backrest incline at the desired angle.

- Tightening will bring the backrest at a more vertical angle (recommended posture for beginners).
- Loosening the backrest will tilt the back support rearward.

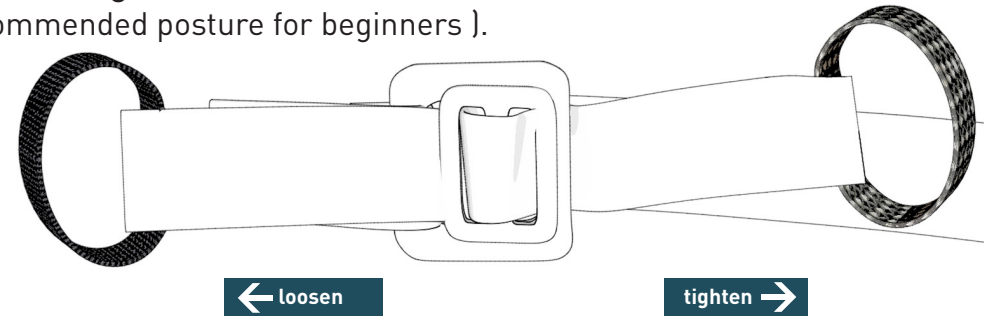

Adjusting the chest strap :



The distance to consider corresponds to the length between the middle points at the bottom of each carabiner. The ideal distance varies between paragliding wing models. Adjust your harness's chest strap according to the wing manufacturer's recommendations.

Tightening the chest-strap provides more stability but less piloting efficiency while increasing the risk of riser twisting.

On the contrary loosening the strap provides more efficiency but can be dangerous in turbulent aerology (increased risk of falling towards the collapsed side of your glider).

To get a "standard" adjustment, the two red marks located on the Safe-T-Bar and on the chest adjustment strap should be matched together.



Adjust the shoulder straps length using the trimmers

The pressure on the shoulder straps contributes to general comfort in flight. It must be precise: not too tight nor too loose. The upper area of the straps must offer enough support to maintain your torso in a comfortable position.

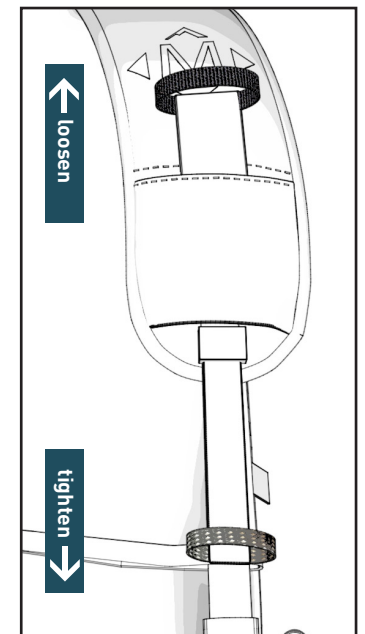

CONNECTING THE WING TO THE HARNESS

Connecting the wing to the harness

Without twisting the risers, connect them to the harness attachment loops using the self-locking carabiners.

Check for the risers to be properly positioned and untwisted. The «A» risers must be located at the front and facing the flight direction (see diagram).

Lastly, check for the main self-locking carabiners to be fully closed and locked in place.

Installing the accelerator

Install the accelerator by following the instructions found on page 12. Connect it to the wing using the split hooks.

Once the accelerator/speedbar is connected, adjust its length according to your measurements. For correct use, there must not be any tension at the split-hook level when the accelerator/speedbar line is fully relaxed.

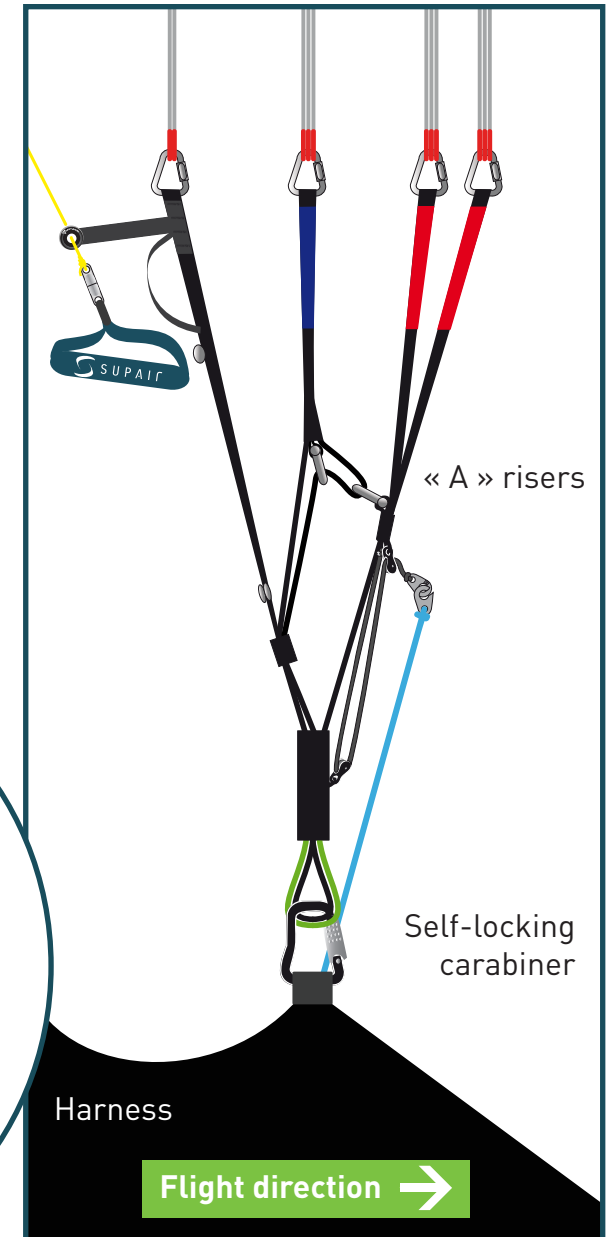
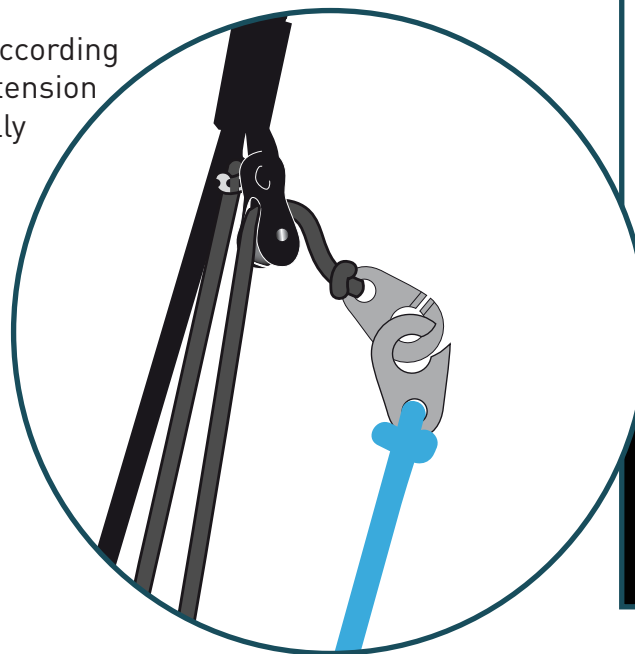

FLIGHT BEHAVIOR



The ACCESS 2 BUMP harness is stable and comfortable. With its geometry allowing easy transition from standing to sitting and protection foam cushions, this harness is ideal for ground handling training exercises. The ACCESS 2 BUMP is aimed at beginners, pilots in progression or looking for great passive safety features (upright flying position, easy running and transition).

To learn more about this harness, we advise you to carry out the first flights with it in stable conditions, preferably flying on-site or in an area that you are familiar with.

Pre-Flight control



- Check that the harness and the carabiners are not damaged..
- Make sure that the reserve parachute safety cables to ride through the closing tabs keeping the reserve rescue pocket flaps closed.
- Check that your personal settings haven't changed.
- Check that all zippers and buckles are closed.
- Check that the speedbar is correctly connected and set up.
- Check that none of the glider lines or any object come into contact with the reserve parachute handle(s).
- Make sure that the self-locking carabiners are locked and connected to the paraglider.

Take-off

After a thorough weather conditions analysis, when the decision to fly has been taken, put your harness on and follow the next steps



- Lock the leg and chest buckles using the Safe-T-system.

Takeoff maintaining a vertical posture and push yourself inside the harness but only once away from the ridge.



Do not release your hands from the brakes when you are close to terrain.

In flight



Once up in the air, the ACCESS 2 BUMP behaviour is stable and instinctive.
Please set the distance between the two carabiners according to aerology and to the wing manufacturer's recommendations.

Speedbar use



We recommend a cautious speed-bar use due to the increased risk of major partial or full frontal collapses.
Use the speed-bar/accelerator (transitions) only when far away from the ridge and in calm weather conditions as the wing becomes more sensitive to turbulence when accelerated. If you feel a loss of tension in the speed-bar/accelerator, stop pushing it and apply a light brake pressure on the toggles to prevent the glider from experiencing a potential frontal collapse.



Warning ! Do not apply pressure on the speed-bar with your feet to push yourself inside the harness (it is not a foot-rest) : risk of a full frontal collapse !!!
To use the speed-bar, maintain one foot on the footrest then with the other, place your foot onto the centering space and push the first bar.

Landing



Straighten yourself in your harness and adopt a running posture to dissipate the horizontal speed.
Always be certain to have enough altitude to make a landing approach corresponding to the weather conditions of the moment and terrain. During the landing approach, never make hasty maneuvers. Always land upwind in a standing posture and be ready to run upon touchdown if necessary.
During your final approach, use as much airspeed as possible based on the weather conditions of the moment, then gradually reduce the glider air speed by pushing the toggles all the way down until contact with the ground is made. **Beware not to brake too soon and too rapidly and too deep which could lead to a stall and a dangerous landing.**
During high wind speed landings, turnaround and face the wing as soon as ground contact is made and move toward the wing while braking symmetrically to deflate it. **Do not land in a seated position as it is dangerous.**

USING THE RESERVE PARACHUTE

Throwing the reserve parachute



We strongly advise you to check frequently the location of the reserve parachute handle location. To do this, we recommend that you lower your right hand following the risers. This movement should be done without looking. By doing so, you will maximize your chances of a rapid extraction if something went wrong and throwing the reserve parachute was called for.

Estimate your AGL (Altitude Above Ground Level), which if high enough may make it worth trying to bring your wing back to a normal flying configuration. If in doubt, quickly deploy your emergency parachute.

Deploying a rescue parachute should be done only in an emergency.



With a strong, lateral and then vertical tug, pull the handle towards you and then throw the parachute away from you (including the container and its handle) toward a clear unobstructed area of the sky. As soon as the parachute deploys, bring as much of the glider as possible toward you by pulling as symmetrically as possible on the "C" or "D" risers or on the toggles/brakes.

Be prepared to land by adopting an upright position, with knees together and legs slightly bent. Prepare to roll down with pivoting shoulders in a paragliding fall (PLF).

TOWING

To takeoff under tow, you must be equipped with a quick release specially designed for the task.

Connect the tow bridle to the wing riser loops with a Dyneema adaptor with a resistance greater or equal to 300kg. The tow bridle will then be fastened by using a lark's head knot or an adapted metal link. To complete the installation, follow the tow bridle reales manufacturer's recommendations.

Before towing, you should consult with a competent towing outfit about safety recommendations.

MANDATORY CONTROLS

Mandatory biannual inspection :



- Ascertain parachute deployment functionality by pulling the handle to activate a clean POD extraction sequence
- Inspect the harness for wear and tear

Annual check :



An annual deployment and repacking of the reserves parachutes must be conducted by competent and certified personnel.

Call for help after an accident

Emergency call numbers



EUROPE / INDIA	112
USA / CANADA	911
CHINA / JAPAN	119
NEPAL	101
IRAN	112
AUSTRALIA	000
NEW ZEALAND	111

Help needed?

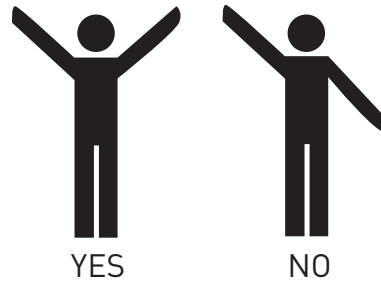

Flashlight SOS :



Harness cleaning and maintenance

It is a good idea to clean your harness from time to time. We recommend using a brush and soft solvents only (soap or mild cleaning agents). Rinse thoroughly. Never use aggressive chemicals such as strong solvents which could be harmful to the harness's fabric, webbings, stitching and weaken its integrity.

The zip fasteners should be lubricated from time to time, using a silicon spray.

If you regularly use your harness in a dusty environment (dirt, sand, etc...), we advise you to regularly check and maintain your carabiners and buckles : clean them with a mild detergent, then blow dry them fully but **DO NOT LUBRICATE !**

Prior to using them, conduct a thorough carabiners and buckles checkup to insure their full functionality.

If you use your harness in a marine/sandy/salty environment, pay particular attention to your gear and follow a rigorous care/maintenance routine.

Storage and transport

When not in use, your harness should be stored inside your paragliding backpack, in a dry, cool and clean place, protected from UV exposure. If your harness is wet, please dry it thoroughly before storing.

For transport, protect the harness from any mechanical or UV deterioration (use a bag). Please avoid long transports in wet conditions.

Life span



Once every two (2) years, a thorough harness inspection must be conducted :

- Webbing wear and tear (no excessive wear, no rip beginning, no unwanted folds)
- Buckles and carabiners (functionality, wear and tear).



The threads and fabric used for the manufacturing of the ACCESS2 BUMP were specifically selected for their quality and resilience levels. However, in particular instances such as long term UV exposure, abrasion, contact with damaging chemicals, general wear and tear, the harness will need to be inspected at a professional certified repair facility. Safety comes first!



The self-locking carabiners are NEVER to be used for any activities other than paragliding.

Independently of the pre-flight check-out, you have to open and unfold your rescue parachute once every year.

Repair

In spite of using the highest quality products to manufacture the ACCESS2 BUMP, it is possible for your harness to deteriorate through general use. If showing any sign of wear and tear, it should be sent for inspection and/or repairs at a professional certified facility.



SUPAIR now offers an extended warranty period reaching beyond the product standard protection plan against manufacturing defects. Please contact us either by telephone or by e-mail sav@supair.com in order to receive a quotation..

Hardware & Parts

- Self-locking zicral 45mm carabiners (Reference:MAILCOMOUS 45)
- Polypropylene seat plate (ref : S : MPPL030 | M : MPPL031 | L : MPPL032 | XL : MPPL033)
- Reserve parachute handle (AC2)
- Speedbar Split-hooks (Reference : MPPM050)

Materials

Fabrics	Webbings	
Nylon ripstop 210D	PES 25mm (1250 daN)	
Cordura 500D	PES 43mm	

Recycling

We have minimized our manufacturing footprint by carefully selecting environmentally friendly materials; most of our components are recyclable.

If you estimate that your ACCESS2 BUMP has reached the end of its life span, you can separate plastics from metals and recycle them according to your community rules in effect. As for the fabric itself, contact your local authorities to find out how to proceed to discard it.

WARRANTY

SUPAIR takes the greatest care in its products design and manufacturing and hence offers a five (5) year limited warranty from the date of purchase against manufacturing defects or flaws occurring during normal use. Any damage or degradation resulting from incorrect or abusive use, abnormal exposure to aggressive factors, including, but not limited to; high temperature, intense sun exposure, high humidity etc, will invalidate this warranty.

DISCLAIMER



Paragliding is an activity requiring specific skills and sound judgement. Learn how to fly within the environment of a certified paragliding school. Carry an insurance policy with you in addition to your pilot certification. Always mind and gauge your personal skills relative to the elements you want to be flying in. Better be safe than sorry ! SUPAIR can not be held responsible for your paragliding decisions or activities.



This SUPAIR product has been designed exclusively for paragliding. Any other activity such as skydiving or BASE jumping is absolutely forbidden.

PILOT'S GEAR



It is essential for you to wear a suitable head protection (certified paragliding helmet), boots and right clothing for the activity. Moreover, carrying a reserve parachute connected to your harness in flight is highly recommend.

BUMPAIR Shock Absorber

The harness you have just purchased has a BUMPAIR type shock absorber.

This protection is intended to protect you against potential impacts. It complies with EU Regulations 2016/425 relating to personal protective equipment (PPE).

The shock absorber CE conformity of your harness is certified by the following laboratory: ALIENOR CERTIFICATION n ° 2754, Z.A. du Sanital, 21 Rue Albert Einstein, 86100 Chatellerault, FRANCE

The storage, transport and maintenance of the BUMPAIR is the same as it is for the harness. The inspection of the protector is the same as it would be for the harness.



Please note that no shock absorber can guarantee total protection against injury. The back protector does not prevent potential injuries to the spine and/or pelvis. In addition, only the parts of the body covered by the shock absorber are likely to benefit from adequate protection against possible impacts.



Please note that the performance of the equipment can be dangerously affected by any modification made or improper use of the shock absorber, and negatively affect the proper functionality of the protector which must be whole and properly installed. You must check that all is in order prior each flight:

- The correct installation of the BUMPAIR shock absorber.
- The BUMPAIR seams and overall condition of the fabrics - look for holes, tears, snags



The protection can have a five (5) year lifespan under normal use conditions.
Warning! Following a major hard landing would justify the protector to be discarded.

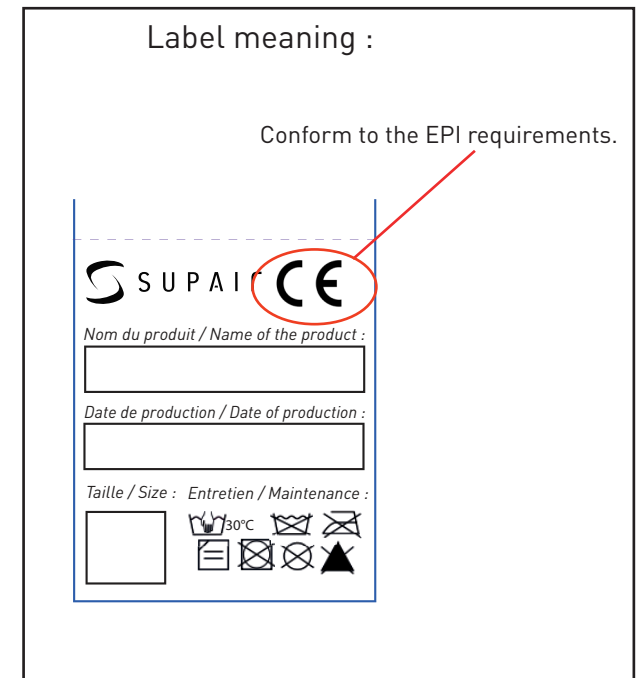

If your BUMPAIR is damaged, have it inspected and repaired at a professional qualified facility or contact us at sav@supair.com

The test results and the EU declaration of conformity can be found at: www.supair.com

This page will help you keep record of your ACCESS2 BUMP scheduled maintenance.

Purchase date	
Owner's name :	
Name and stamp of the shop :	

<input type="checkbox"/> Care	
<input type="checkbox"/> Resale	
Date	
Workshop's name/ Buyer's name	

<input type="checkbox"/> Care	
<input type="checkbox"/> Resale	
Date	
Workshop's name/ Buyer's name	

<input type="checkbox"/> Care	
<input type="checkbox"/> Resale	
Date	
Workshop's name/ Buyer's name	

<input type="checkbox"/> Care	
<input type="checkbox"/> Resale	
Date	
Workshop's name/ Buyer's name	



SUPAIR-VLD
Parc Altaïs
34 rue Adrastée
74650 Chavanod, Annecy
FRANCE

info@supair.com
+33(0)4 50 45 75 29

RCS 387956790

■ ■ DESIGNED
■ ■ IN ANNECY

 100% MADE
IN EUROPE