



User manual  
**FLUID LIGHT**

SUPAIR  
34 rue Adrastée  
Parc Altaïs  
74650 Annecy - Chavanod  
FRANCE

45°54.024'N / 06°04.725'E

[www.supair.com](http://www.supair.com)

English  
Revision index: 30/07/2019



Thank you for choosing the FLUID LIGHT reserve parachute! We are glad to be able to share our common paragliding passion with you.

Thank you for choosing to fly our FLUID LIGHT reserve. We are delighted to have you on board and to share our passion for paragliding.

We hope you will find this user's manual comprehensive, explicit and hopefully enjoyable as well. We advise you to read it carefully.

You will find the latest information and updates on this product on our website : [www.supair.com](http://www.supair.com). If however you have any further questions, do not hesitate to ask one of our dealers. And of course the entire SUPAIR team remains at your disposal on [info@supair.com](mailto:info@supair.com)

We wish you many safe and enjoyable flying hours, and happy landings.

Team SUPAIR

# List of contents

<b>Introduction</b>	<b>4</b>
<b>Technical specifications</b>	<b>5</b>
<b>Equipment overview</b>	<b>6</b>
<b>EN 1249 Norm</b>	<b>7</b>
<b>Use</b>	<b>9</b>
<b>Reserve individual parachute connection</b>	<b>11</b>
<b>Reserve tandem parachute connection</b>	<b>13</b>
<b>Reserve individual parachute/harness connection</b>	<b>15</b>
<b>Packing individual reserve</b>	<b>16</b>

<b>Packing tandem reserve</b>	<b>27</b>
<b>Measurement table</b>	<b>38</b>
<b>Maintenance</b>	<b>42</b>
<b>Warranty</b>	<b>43</b>
<b>Disclaimer</b>	<b>43</b>
<b>Service Book</b>	<b>44</b>



Welcome to the world of free flying : a shared world of passion.

The FLUID LIGHT parachute meets all the requirements emphasizing safety and lightness while providing better performance than TRADITIONAL models: Faster opening, more stability, and a lower sink rate. It's currently one of the lightest square rescue parachute (1180g, in size S)

The reserve parachute FLUID LIGHT was designed by the SUPAIR in-house research and development team. This model aims above all, to be a high-end quality product ensuring optimal safety.

We use known materials for best results and highest performance. The design and material choices were well thought-out in regard to longevity and quality.

SUPAIR's reserve parachute FLUID LIGHT reserve was certified EN 12491 and LTF 91/09

Indicating that it meets European and German safety requirements.

After reading this manual, we recommend you to conduct a harness hang-test before your first flight to ensure proper rescue setup and functionality.

N.B: Three important icons will help you when reading this manual



Advice



Caution !



Danger !!

<b>FLUID LIGHT</b>	Size S	Size M	Size L	Tandem
Total Hooking Weight* mini - maxi (kg)	65 - 90	85 - 105	100 - 125	105 - 220
Weight (kg)	1,10	1,28	1,46	2,83
Surface area (m <sup>2</sup> )	22,6	27,7	32,2	63,7
Volume (cm <sup>3</sup> )	3 800	5 500	6 300	7 600
Opening Time (s)	2,5	2,5	2,5	2,5
Projected Cone length (m)	4,2	4,6	5,0	7,32
Steerable	Non			
Possible Adjustment	Non			

\* Total flying weight without the glider.

# Equipment overview

- 1 Folded reserve parachute inside its deployment bag ( POD )
- 2 Label with serial number, and manufacturing date.
- 3 Single reserve parachute bridle loop.



## OPTIONS

- 4 Split risers
- 5 Y Tandem risers
- 6 Maillons Rapides® 6mm
- 7 Flexible toric rings

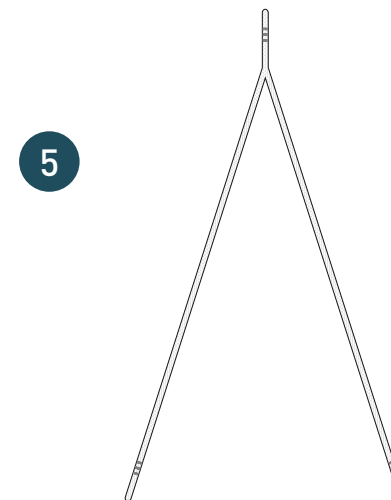
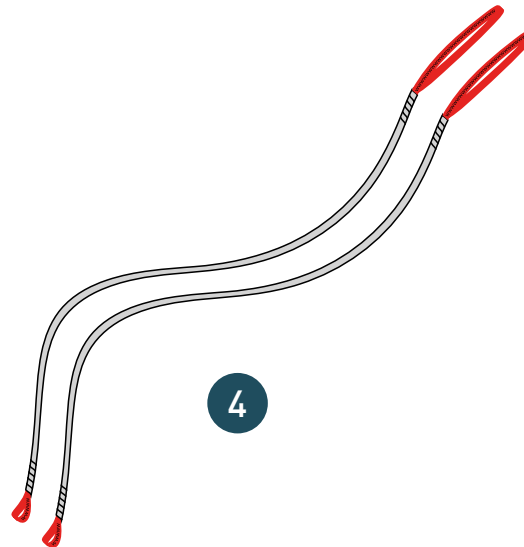

This notice shows the information requested by the EN 1291 norm. This European Norm (EN) is required for all the paragliding reserve parachutes. All our reserve parachutes are conforming to the EN norm.

The reserve parachute certification code EN 12491 is described as follows:

- Flight proper sequence: during a straight flight, the reserve parachute is deployed. In order to conduct accurately reproducible tests by avoiding any interference from the paraglider, the test-pilot releases his paraglider at peak height during a roll to begin the descent with an important instability factor.

- The maximum sink rate is measured during the last 30 meters, the paragliding wing is released, below or equal to 5,5 m/s under maximum load.

- Stability is checked in a subjective visual way ( with a rolling effect or not ), and is gauged against the overall sink rate ( an unstable reserve parachute usually demonstrates a higher sink rate).

- The reserve parachute opening speed must be inferior to 5 seconds.

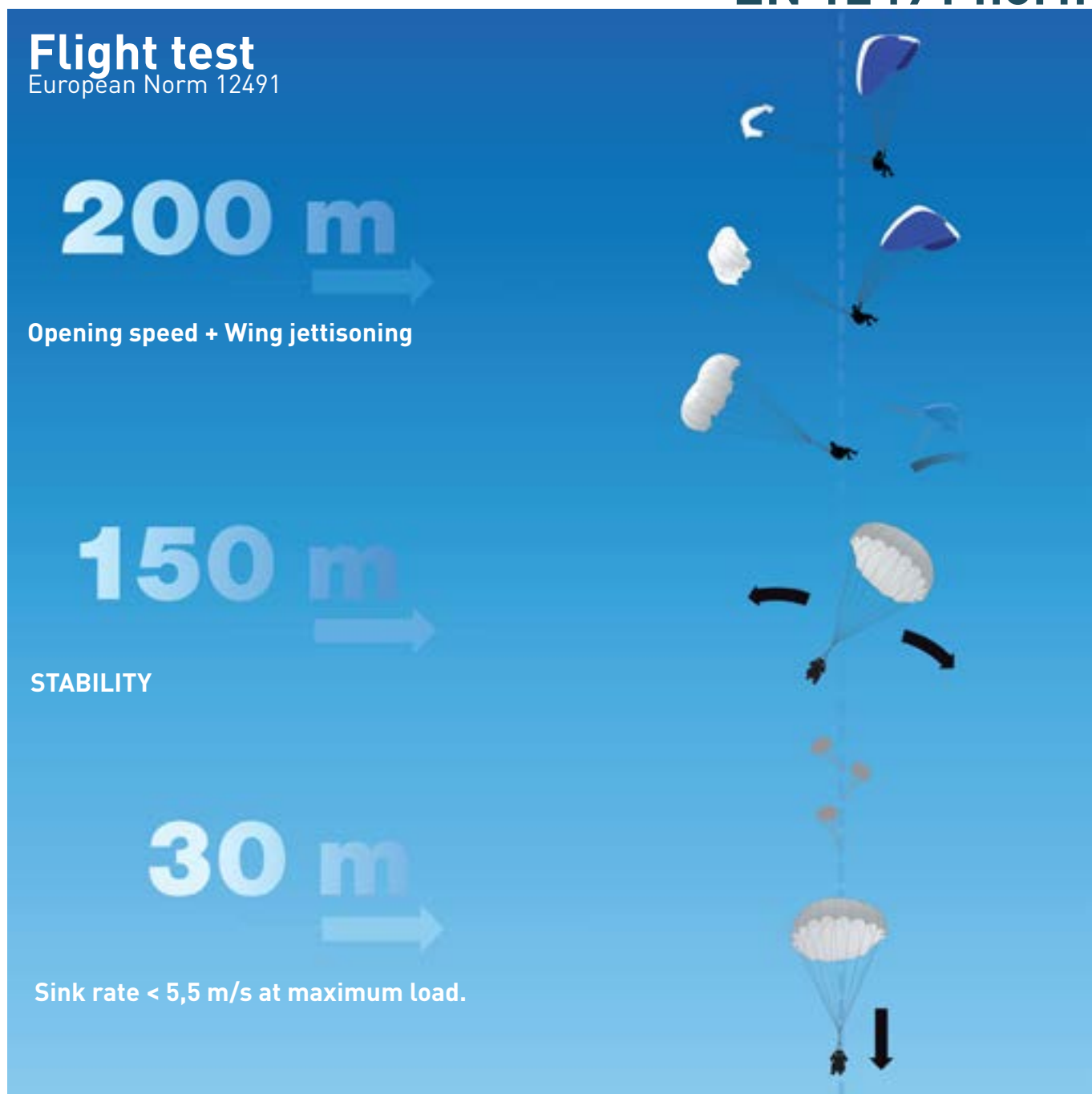

The certification results can be found at [www.supair.com](http://www.supair.com)

## Norme EN 12491

### STRUCTURAL TEST EUROPEAN NORM 12491



Structural tests ( resistance ): consists of verifying the overall structural integrity of the parachute under maximal load for a given horizontal 32 m/s speed.

There can not be any failure / damage taking place on the riser / lines / canopy cascade during the entire procedure.





# Reserve Parachute Owner's Manual

## Guideline procedures to follow with our reserve parachutes:

To begin with, we must stress that using a reserve parachute should never be taken for granted or considered to be without risks to the pilot. A reserve parachute is only there to deploy in case of an emergency situation.

- **The pilot's weight must conform to the parachute manufacturer's recommended load limitations to be fully operational.** Any intent to use a reserve parachute below or above the manufacturer's recommended weight limitations is dangerous and must totally be avoided.
- The reserve parachute must NOT be deployed at a speed greater than 32m/s (115km/h)
- Any reserve parachute riser connection to the harness must result with the pilot landing on his legs and standing.
- The parachute must be left unmodified to keep it aligned with the certification procedure it went through to assure for a proper deployment sequence to take place. The Fluid reserve parachute has been tested and certified with his own original SUPAIR inner container (POD). Different results and opening failures may appear using a different POD. Therefore, the FLUID LIGHT is not to be used with any other inner container than the original SUPAIR pod.
- It is very important to learn how the parachute works, and only during a SIV course (Simulated Flight Incident ) or equivalent exercise.
- The FLUID LIGHT must not be used for tandem flying as you may exceed the upper load limit.

## Deploying the Reserve Canopy:

- Find the deployment handle.
- Hold it firmly and pull it out of the outer container or harness.
- Using the deployment handle, jettison the inner pod forcefully into open air and AWAY from the paraglider. The reserve parachute pod will automatically open upon reaching maximum line and riser length once under tension.
- Due to its square design, the canopy will easily and quickly inflate.
- Once the reserve parachute is deployed, the pilot must disable the paraglider by symmetrically pulling as much as possible on the «B» risers to bring the rescue overhead to stabilize the descent.
- Upon landing, the pilot must be ready to cushion the impact by flexing his legs and roll sideways

Note : Our tandem reserves are delivered with an automatic glider deflection system to limit the influence of the wing on the behavior of the whole. This system (called «André Rose») does not exist for individual reserve yet.

To prepare the landing, the pilot must be ready to absorb the impact with his legs and usual required technicals like PLF (Parachute Landing Fall for example).

## Recommendation And Care For The Parachute After A Water Landing:

- In case of a water landing, the parachute must be dried, followed by line stretching and reconditioning, following the manufacturer's guide lines.
- Let the parachute dry outdoors in a shaded area, away from direct sunlight.
- Pre-stretch the lines with a 30 kg., (50 kg. load for the Apex) in order to limit Nylon shrinkage due to moisture and humidity. It is preferable to check the lines length with a 10 kg. load (see measurements chart on page 38).
- Proceed with the repacking procedure according to the manufacturer's guide line manual.
- Ensure a correct reserve parachute installation inside the harness by doing an extraction during a hang-test. Repeat installation procedure afterward.

**To be noted:**

An EN12491 certified reserve parachute must theoretically have a touch-down speed, equal or inferior to 5,5 m/s, which corresponds to a 1,80 meter jump. This impacting speed can greatly vary due to a few relevant factors: The air mass, the overall hooking weight, the paragliding wing configuration / design, and the density altitude. Two recent flight incidents with use of similar reserve parachute models ( X-Light ) during similar circumstances, demonstrated significant different results:

- One pilot touched-down with a 5,2 m/s sink rate with his paraglider disabled.
- The second pilot touched-down with a 9 m/s sink rate without a neutralized paragliding wing, or a free-fall jump from a 4 meter elevation

The paragliding wing's influence on the overall set-up ( paraglider / reserve parachute ) is important and not predictable nor quantifiable. The scenario can not be reproduced during the tests.



**In spite of the positive statistics showing the obvious benefits of using a reserve parachute in case of an emergency, the later can not be taken for granted at any time or place.**

# Connecting individual reserve parachute

First of all, take care that your reserve is compatible with the harness you want to use with. In case you will use protection accessories (Bumpair, airbag), it must be installed in the harness first, then check that your rescue fits well in the reserve container, without too much space or compression.

You will need :

- 1 x Standard separate Dyneema® risers ( Réf.: ELESOLODYNEEMA )
- 1 x 7mm square Maillon Rapide® ( Réf.: MAILCARIN7 )
- 5 x «0» toric rings ( Réf.: MPPP044 )

## >> Individual reserve connection : Harness - Separate Risers

- 1** - Take two (2) square 6mm Maillons Rapides® and two (2) flexible toric rings.  
 - Unfasten the Velcros (or zip) located alongside the shoulder protective sleeves to reach the reserve parachute connection loops on the shoulder straps.

- 2**  
 - Open the Maillon Rapide®  
 - Push the bridle's buckle through.  
 - Push the maillon through the flexible toric ring.  
 - Twist

- 3**  
 - Push the riser's loop through the flexible toric ring.  
 - Push the maillon through the riser's loop.

- 4**  
 - Give a second twist to the toric ring.  
 - Push the Maillon Rapide® through the riser loop.

- 5**  
 - Tidy up the assembly.  
 - Be certain that the risers end loops are securely in place.  
 - Close the maillon tightly by hand.  
 - Complete tightening with pliers by making a ¼ tightening turn.

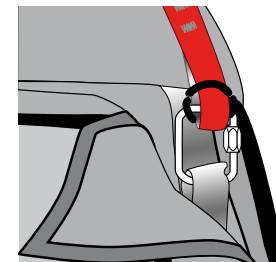
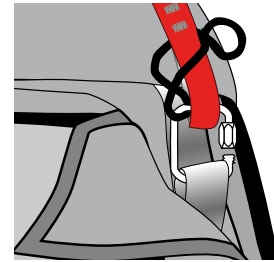
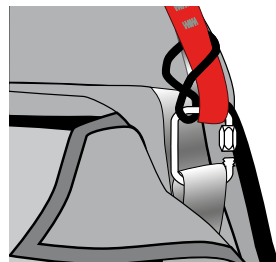
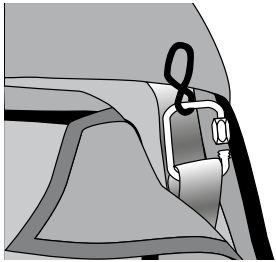

- 6**  
 Repeat sequence 1 through 5 on the other side of the harness.

- 7**  
 Tuck away the risers excess ( without making knots ) under one single flap :  
 - Either to the right side if you wish to place your reserve parachute handle to the right ( recommended if right handed ).  
 - Or to the left side if you wish to place your reserve parachute handle to the left ( recommended if left handed ).  
 - Close the protective sleeves Velcros (or zip).

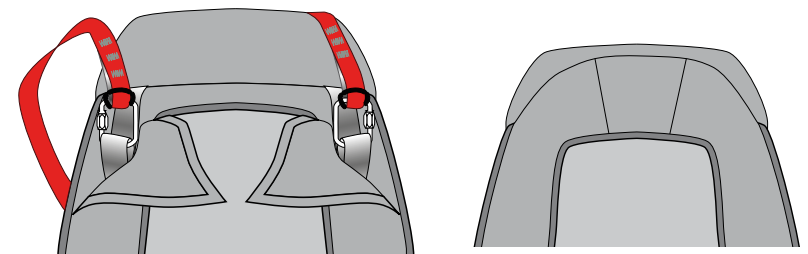

# Connecting : reserve parachute - harness

## >> Separate riser - reserve parachute connection.

One (1) square 7mm Maillon Rapide® will be needed + three (3) flexible toric rings.

1

- Open the 7mm square Maillon Rapide®.
- Push the maillon through the toric ring
- Twist

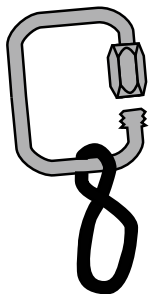

2

- Push the end of the short riser through the toric ring.
- Push the maillon through the risers buckles.

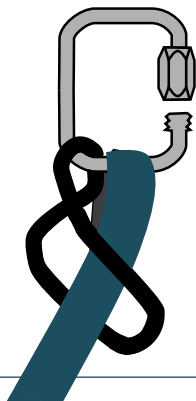

3

- Give a second twist to the toric ring.
- Push the buckle through the maillon.

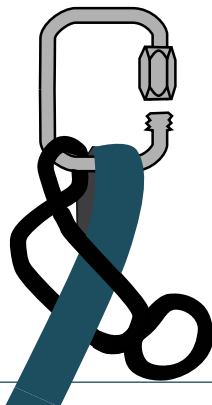

4

- Give a slide to the riser towards the other side of the Maillon Rapide®

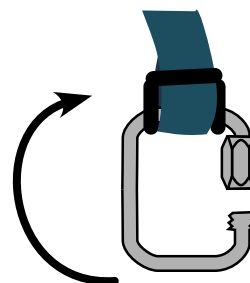

5

- Repeat sequence 1 through 3 with the 2 bridles successively.

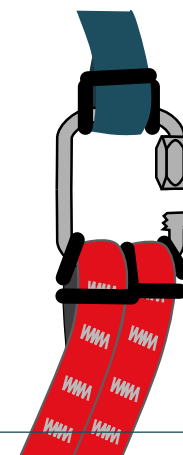
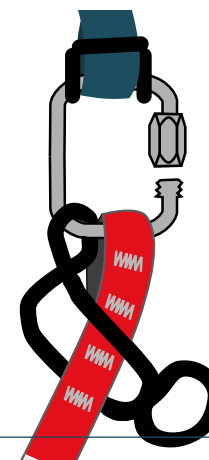

6

- Tidy up the assembly.
- Be certain for the riser end loops to be securely fastened.
- Close the Maillon Rapide® tightly by hand.
- Tighten using pliers and making a 1/4 turn.

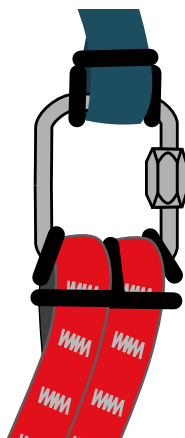

# Connecting Tandem reserve parachute

First of all, take care that your reserve is compatible with the harness you want to use with. In case you will use protection accessories (Bumpair, airbag), it must be installed in the harness first, then check that your rescue fits well in the reserve container, without too much space or compression.

You will need :

- 1 x Tandem «Y» Dyneema® risers ( Réf.: ELESBIY )
- 3 x 7mm square Maillon Rapide® ( Réf.: MAILCARIN7 )
- 4 x «O» toric rings ( Réf.: MPPP044 )

## >> «Y» Tandem risers direction :

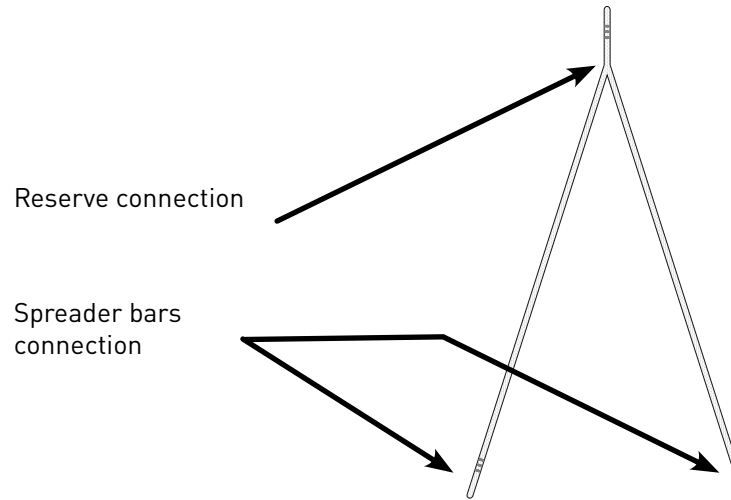

## >> «Y» tandem riser - reserve parachute connection.

1

- Open the Maillon Rapide®
- Push the maillon through the flexible toric ring.
- Twist

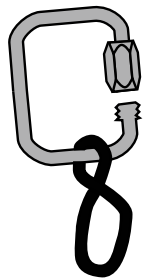

2

- Push the short riser's loop through the flexible toric ring.
- Push the maillon through the riser's loop.

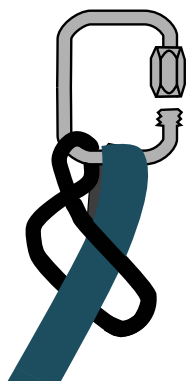

3

- Give a second twist to the toric ring.
- Push the Maillon Rapide® through the riser loop.

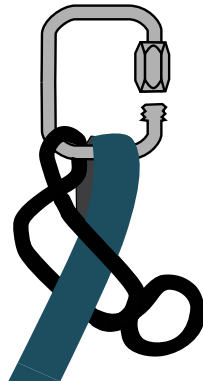

4

- Give a slide to the riser towards the other side of the Maillon Rapide®

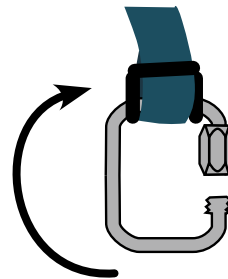

5

- Repeat sequence 1 through 5 with the upper side of the «Y» tandem risers.

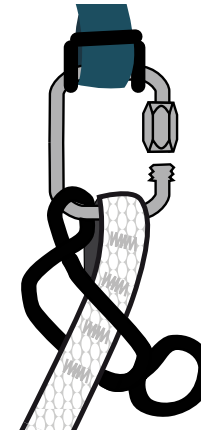

6

- Tidy up the assembly.
- Be certain that the risers end loops are securely in place.
- Close the maillon tightly by hand.
- Complete tightening with pliers by making a ¼ tightening turn.

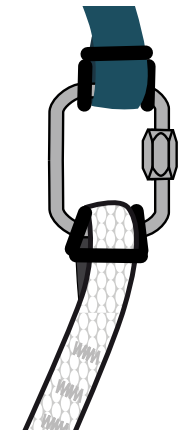

# Connecting Tandem reserve parachute

## >> Tandem spreader bars >> «Y» tandem riser connection.

- 1 Two (2) square 7mm Maillon Rapide® will be needed + two (2) flexible toric rings.
- 2 Following again the process explained on previous page.  
Connect one riser's bridle to one spreader bar's main attachment point  
Repeat the same sequence for the both sides

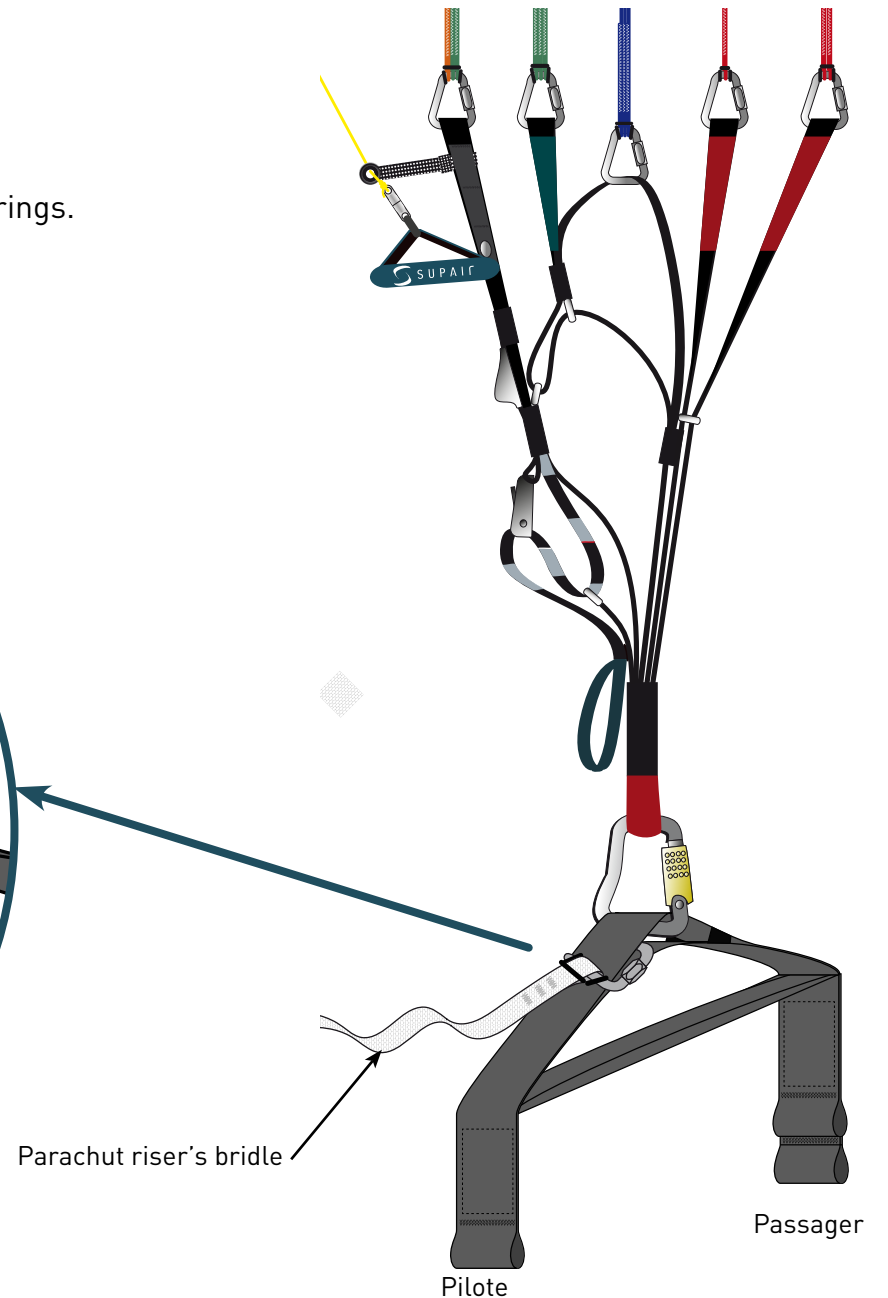
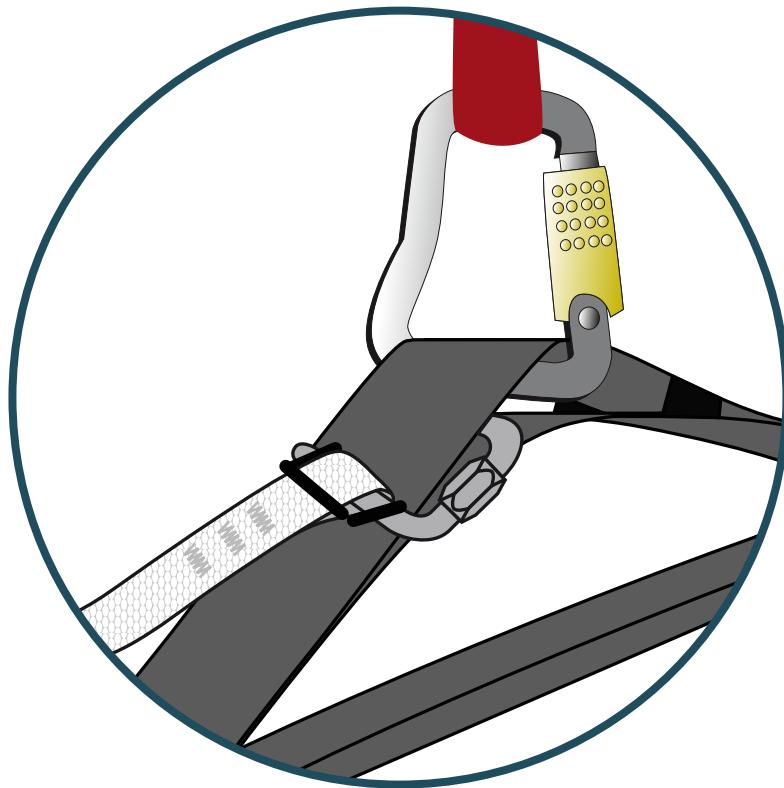

# Connecting the reserve parachute to the harness

## >> Installing the parachute in its container (individual or tandem).

Whether you have an outer front container or an integrated reserve parachute pocket in your harness, proceed with the installation according to the manufacturer's guidelines.



**Check the completed installation during a hang-test.**

The hang-test must happen with the harness completely equipped. If your harness comes with a removable protection, it should be installed before the test extraction.

Have the installation checked by a professional outfit.

Conduct an extraction test every six ( 6 ) months to ensure proper system functionality.

Note : conducting a hang-test extraction does not imply deploying the reserve parachute which will stay inside its POD.

**Advise :** In order to guaranty a quick opening speed and a sound structural integrity, your reserve parachute must be repacked every six months. Take advantage of the repacking procedure to conduct a hang-test extraction.



**Reserve parachute folding and installation inside the harness must conform to the specific guidelines found in this manual.**

# Packing individual reserve



**Packing a reserve parachute is not very difficult but requires a methodical and precise folding procedure. If you feel uneasy about repacking the reserve parachute yourself, it will be advisable for you to seek professional assistance to do the job correctly.**

**Tip: take advantage of having to repack your parachute, to deploy it on the ground and vent it for a while, prior proceeding to folding it again.**

Before each repacking procedure, the following sequence must be observed:

- Carefully check each line from the canopy to the riser for any possible damage.
- Aerate the parachute for at least twelve ( 12 ) hours. Not in direct sunlight nor in a room filled with polluting chemical agents ( sprays ).
- Check the fabric for damage or soiling of any kind.
- Inspect the pod and parachute pocket for wear and tear to ensure a clean extraction using a properly fastened reserve parachute handle to the pod.
- Inspect the elasticated loop keeping the pod flaps securely closed.
- If you notice something unusual, send your parachute to be inspected by a professional specialized certified outfit.

## 1. Folding preparation

**a. Make a selective list of the following items needed to complete the repacking procedure:**

- The unfolded parachute
- A small thin piece of line about 30cm long.
- A fixed point and the necessary means to connect the single reserve parachute riser.
- Sand ballast, weights or books.
- Elastics to keep the lines in place.
- A pen.
- the POD.

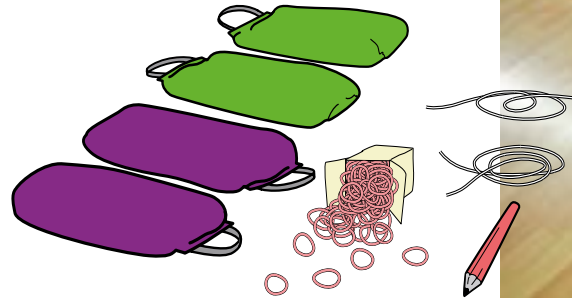

**b. Attach the parachute on a fixed point to keep it stretched and under tension.**

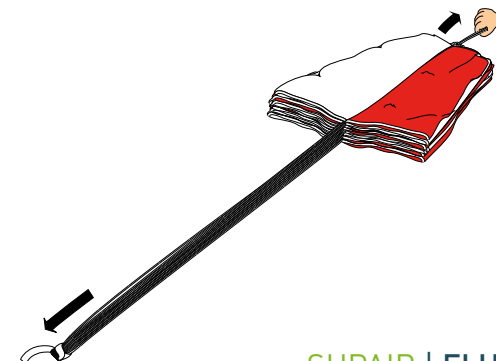



# Packing individual reserve

## 1. Folding preparation (continued).

### c. Keep the parachute unruffled

Check for the lines to run freely from the bridle «loop to loop» connection to the canopy's leading edge.



Divide the parachute in two sections (12 lines on each side), the Apex line must be placed in the middle. Layout the parachute on the ground.



### d. Take the first panel and lay it out flat on the floor.

Choose one of two white panels directly adjacent to a symmetrical red panel



# Packing individual reserve

## 2. Assembling the lanyards

- a. Take the cord and push it through the lanyard of the first panel.
- b. Follow the leading edge to the next line, then the panel's seam to find the second lanyard.
- c. Proceed in the same way until you have assembled all twenty four (24) lanyards.
- d. Slightly tension the parachute on its longitudinal axis.



The lanyard is a small loop strap.



Then, firmly hold the cord keeping the lanyards tightly assembled together.

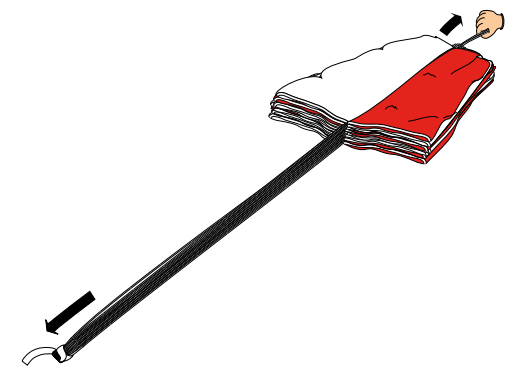

# Packing individual reserve

## 3. Folding the panels

Do not forget to firmly hold the cord keeping the lanyards together so that they remain assembled during the folding procedure.

### a. Extract and flatten the first panel ( tag ).

This panel is white, sewn to a red symmetrical panel. It is laid out flat in one motion and rectangular shape using the fold mark.



### b. Follow the leading edge to find the second panel.

This panel is white and laid out flat in one motion in a rectangular shape using the fold mark.

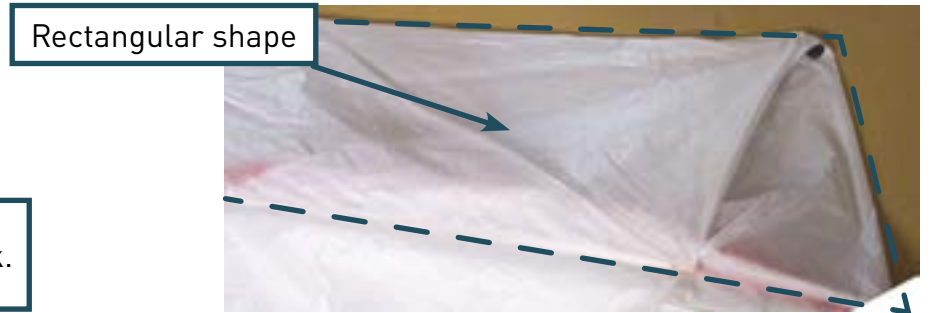

### c. Follow the leading edge to find the third panel.

This panel is white and it's an angle panel . It should be laid out flat in two motions: in a W-shape using the fold mark.



# Packing individual reserve

## 3. Laying out the panels (continued).

### d. Follow the leading edge to find the fourth panel.

This panel is white and it's an angle panel . It should be laid out flat in two motions: in a W-shape using the fold mark.



Excess fabric storage.



When folding the corner panels, pay attention to the excess fabric which must be tucked away flat inside the panel.

### e. Follow the leading edge to find the fifth panel.

This panel is white and laid out flat in one motion in a rectangular shape using the fold mark.

### f. Follow the leading edge to find the sixth panel.

This panel is white and laid out flat in one motion in a rectangular shape using the fold mark.

>> Once the first side is folded, continue by repeating steps «a» to «d» in order to fold the other three sides in the same manner.



Flattening reserve :



# Packing individual reserve

## 4. Dividing the parachute in two sections.

Do not forget to firmly hold the cord keeping the lanyards assembled together during the folding procedure.

Follow this step to layout the parachute flat and symmetrically. Red panels on a side, whites on the other.

By reversing the previous folding motions, re-open the parachute in two halves and symmetrically on the floor.

Return a red rectangular panel (1), a second red rectangular panel (2), a red panel W-shape (3), and a second red panel W-shape (4), a red rectangular panel (5), a second red rectangular panel (6), all twice.

Stop at the first white panel (7).



Middle= is divided with the same number of panels on each side.



# Packing individual reserve

## 5. Folding the parachute.

Do not forget to firmly hold the cord keeping the lanyards assembled together during the folding procedure.

a. Fold in 2 parts each side of the parachute (1 folds), then fold one half over the other to make one long layer with the width of the POD.



Use clips or sandbags to keep the folds in place during the folding procedure.

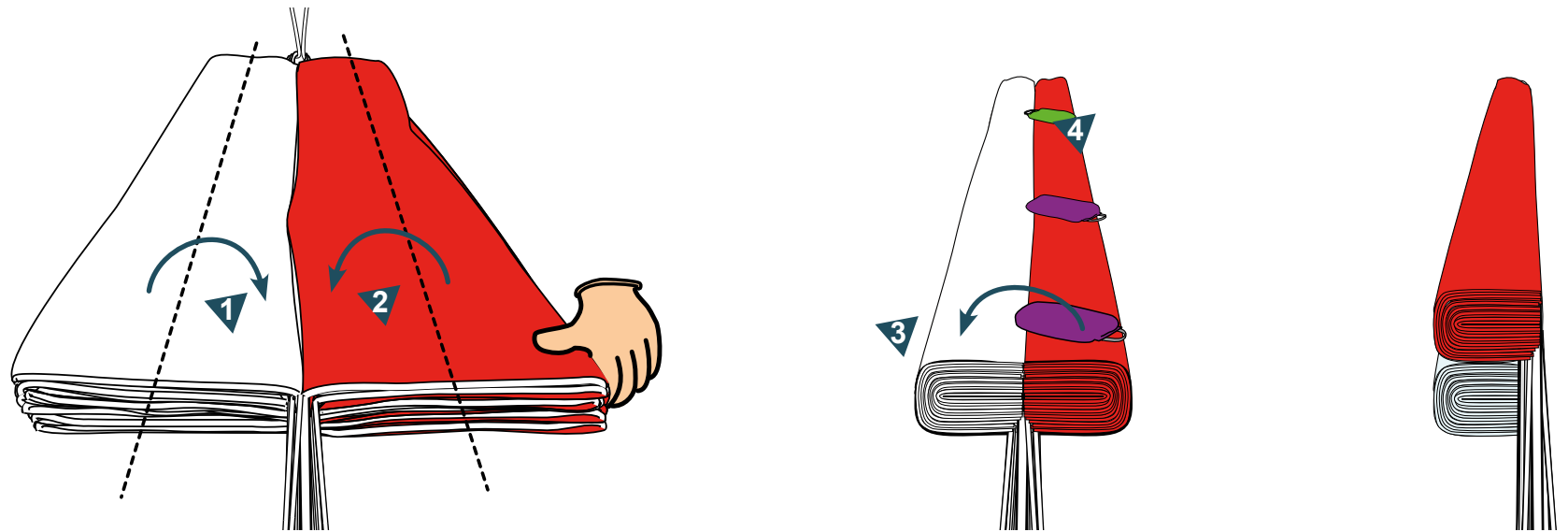

# Packing individual reserve

## 5. Folding the parachute (continued).

Do not forget to firmly hold the cord keeping the lanyards assembled together during the folding procedure.

### b. Coiling the canopy.



**IMMEDIATELY REMOVE THE CORD HOLDING THE LANYARDS TOGETHER !**

Remove the folding cord (which you mounted on the apex in Step 2) by pulling on the small white strap sewn on it.



# Packing individual reserve

## 6. Installing the reserve parachute inside its POD.

a. Place the POD atop the parachute, then flip it all upside down while leaving a small space in front of the leading edge for subsequent line coiling.

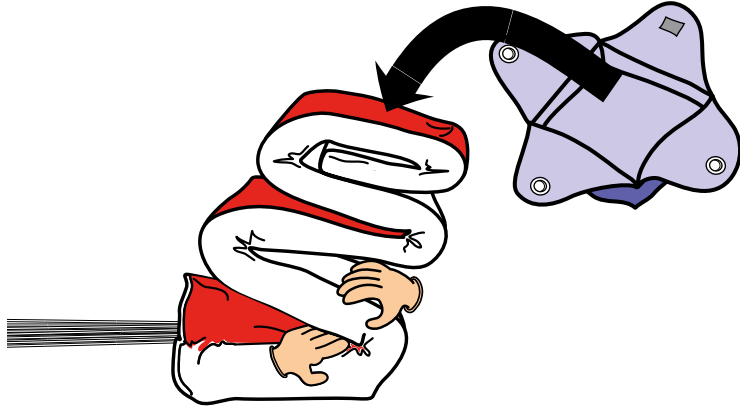

Position the POD's elastic loop opposed to the suspension lines.



Do not pull the lines, they must not be under tension and best left slightly slackened atop the canopy.

b. Close the rear flap and two side flaps.

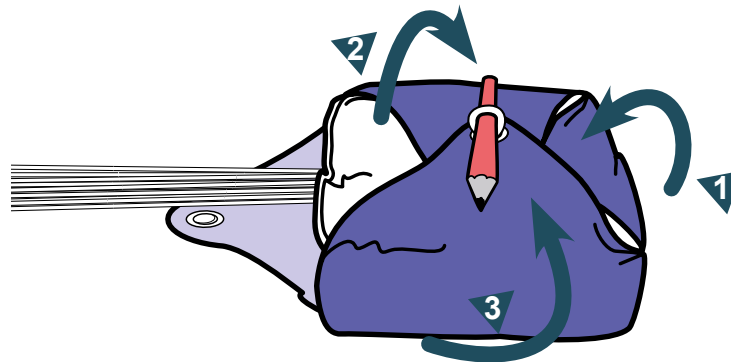



# Packing individual reserve

## 6. Placing the parachute in its POD (continued).

c. c. Coil the lines into the space in front of the canopy while keeping 1.20 m of lines for the outer coiling.

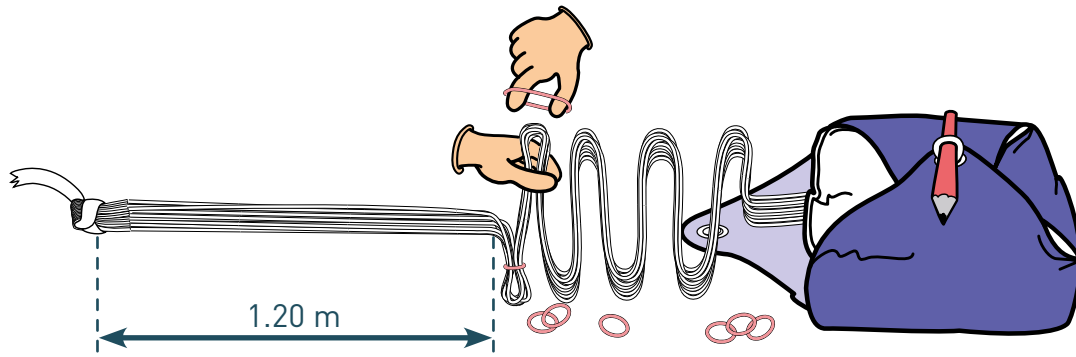

Installation marker.  
>> The suspension line loops must have a two fingers width.

d. Tuck away the coiled lines inside the space in front of the canopy while keeping a 1.20m line length for the subsequent outer coiling.

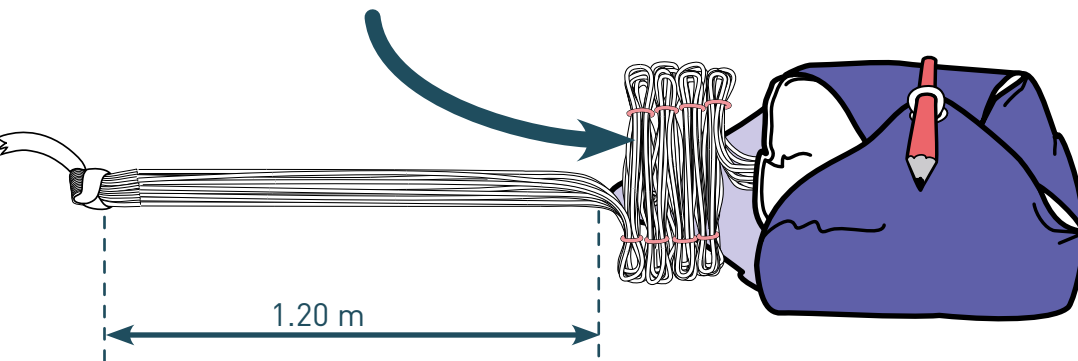

# Packing individual reserve

## 7. Closing the POD.

a. Close the fourth flap and push a 5cm ( 3 fingers ) line loops through the POD elastic loop to secure the flaps in place.

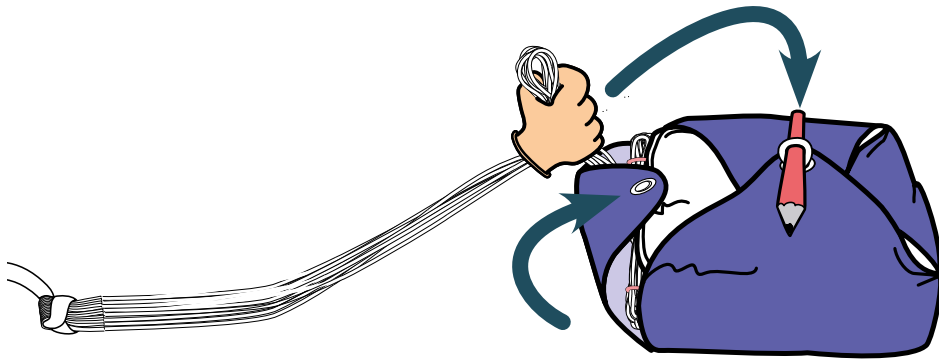

Installation marker.  
>> Loop width = 3 fingers.



≈ 1 m loose lines.



The folding procedure is completed.

b. Make sure that all the equipment needed for the packing procedure is accounted for, and that none of it was mistakenly left inside the folded parachute.



A video about the use and folding of the parachute is available on our website.

# Packing tandem reserve



**Packing a reserve parachute is not very difficult but requires a methodical and precise folding procedure. If you feel uneasy about repacking the reserve parachute yourself, it will be advisable for you to seek professional assistance to do the job correctly.**

**Tip: take advantage of having to repack your parachute, to deploy it on the ground and vent it for a while, prior proceeding to folding it again.**

Before each repacking procedure, the following sequence must be observed:

- Carefully check each line from the canopy to the riser for any possible damage.
- Aerate the parachute for at least twelve ( 12 ) hours. Not in direct sunlight nor in a room filled with polluting chemical agents ( sprays ).
- Check the fabric for damage or soiling of any kind.
- Inspect the pod and parachute pocket for wear and tear to ensure a clean extraction using a properly fastened reserve parachute handle to the pod.
- Inspect the elasticated loop keeping the pod flaps securely closed.
- If you notice something unusual, send your parachute to be inspected by a professional specialized certified outfit.

## 1. Folding preparation

**a. Make a selective list of the following items needed to complete the repacking procedure:**

- The unfolded parachute
- The small thin piece of line stored in the pod's pocket
- A fixed point and the necessary means to connect the single reserve parachute riser.
- Sand ballast, weights or books.
- Elastics to keep the lines in place.
- A pen.
- the POD.

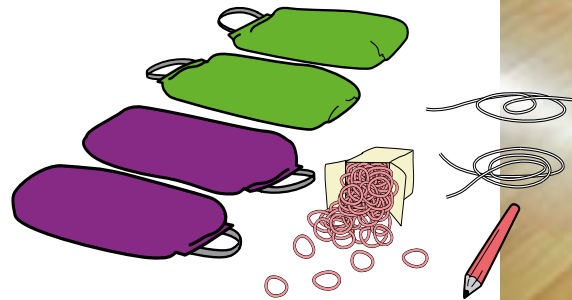

**b. Attach the parachute on a fixed point to keep it stretched and under tension.**

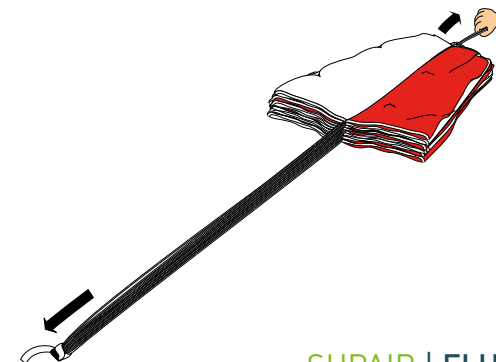

# Packing tandem reserve

## 1. Folding preparation (continued).

### c. Keep the parachute unruffled

Check for the lines to run freely from the bridle «loop to loop» connection to the canopy's leading edge.



Divide the parachute in two sections (18 lines on each side), the two low Apex line with the nine high lines must be placed in the middle. Layout the parachute on the ground.



### d. Take the first panel and lay it out flat on the floor.

Choose one of two white panels directly adjacent to a symmetrical red panel.



# Packing tandem reserve

## 2. Assembling the lanyards

- a. Take the cord situated on the Pod's pocket.
- b. Push it through the lanyard buckle sewed on the Apex .
- c. Push it through the two loops of this line put side by side
- d. Then push it through the first panel lanyard buckle
- e. Follow the leading edge to the next line, then the panel's seam to find the second lanyard.
- f. Proceed in the same way until you have assembled all twenty four (33) lanyards (32+ 1 apex).
- g. Slightly tension the parachute on its longitudinal axis.



The lanyard is a small loop strap.



Then, firmly hold the cord keeping the lanyards tightly assembled together.

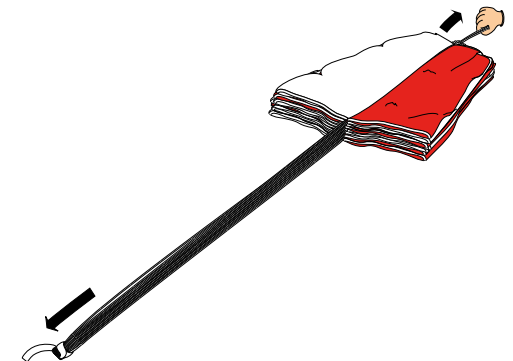

# Packing tandem reserve

## 3. Folding the panels

Do not forget to firmly hold the cord keeping the lanyards together so that they remain assembled during the folding procedure.

### a. Extract and flatten the first panel ( tag ).

This panel is white, sewn to a red symmetrical panel. It is laid out flat in one motion and rectangular shape using the fold mark.



Aligning the leading edge.



Flattening the first panel

### b. Follow the leading edge to find the second panel.

This panel is white and laid out flat in one motion in a rectangular shape using the fold mark.



Fold mark.

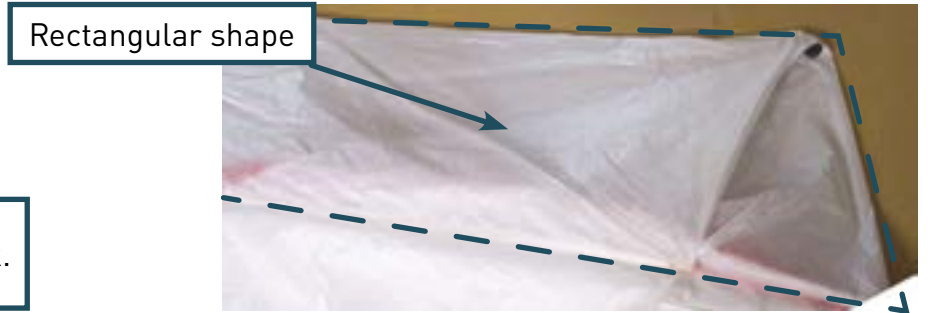

Rectangular shape

### c. Follow the leading edge to find the third panel.

This panel is white and it's an angle panel . It should be laid out flat in two motions: in a W-shape using the fold mark.



# Packing tandem reserve

## 3. Laying out the panels (continued).

### d. Follow the leading edge to find the fourth panel.

This panel is white and it's an angle panel . It should be laid out flat in two motions: in a W-shape using the fold mark.



Excess fabric storage.



When folding the corner panels, pay attention to the excess fabric which must be tucked away flat inside the panel.

### e. Follow the leading edge to find the fifth panel.

This panel is white and laid out flat in one motion in a rectangular shape using the fold mark.

### f. Follow the leading edge to find the sixth panel.

This panel is white and laid out flat in one motion in a rectangular shape using the fold mark.

### g. Follow the leading edge to find the seventh panel.

This panel is white and laid out flat in one motion in a rectangular shape using the fold mark..

### h. Follow the leading edge to find the eighth panel.

This panel is white and laid out flat in one motion in a rectangular shape using the fold mark.

>> Once the first side is folded, continue by repeating steps «a» to «h» in order to fold the other three sides in the same manner.



Flattening reserve :



## 4. Dividing the parachute in two sections.

Do not forget to firmly hold the cord keeping the lanyards assembled together during the folding procedure.

Follow this step to layout the parachute flat and symmetrically. Red panels on a side, whites on the other.

By reversing the previous folding motions, re-open the parachute in two halves and symmetrically on the floor.

Return a red rectangular panel (1), a second red rectangular panel (2), a third red rectangular panel (3) a red panel W-shape (4), and a second red panel W-shape (5), a red rectangular panel (6), a second red rectangular panel (7), and a last red rectangular panel (8) all twice.

Stop at the first white panel (8).



Middle= is divided with the same number of panels on each side.





# Packing tandem reserve

## 5. Folding the parachute.

Do not forget to firmly hold the cord keeping the lanyards assembled together during the folding procedure.

a. Fold in 2 parts each side of the parachute (1 folds), then fold one half over the other to make one long layer with the width of the POD.



Use clips or sandbags to keep the folds in place during the folding procedure.

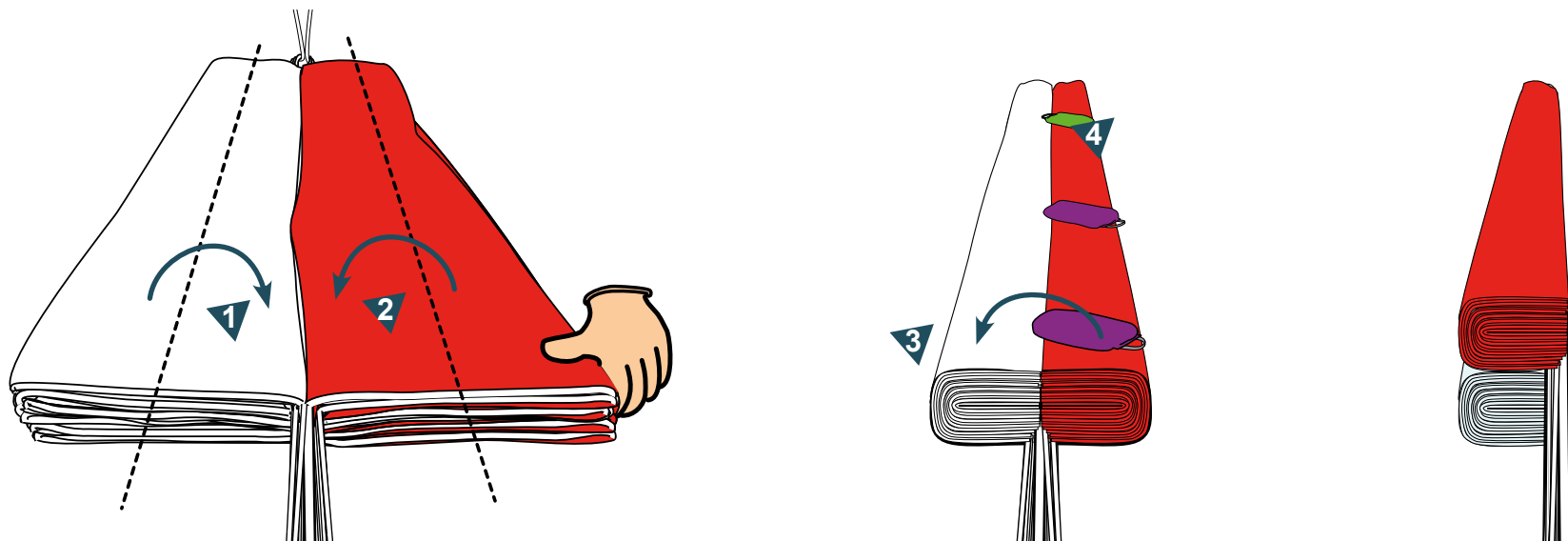

# Packing tandem reserve

## 5. Folding the parachute (continued).

Do not forget to firmly hold the cord keeping the lanyards assembled together during the folding procedure.

### b. Coiling the canopy.



**IMMEDIATELY REMOVE THE CORD HOLDING THE LANYARDS TOGETHER !**

Remove the folding cord (which you mounted on the apex in Step 2) by pulling on the small white strap sewn on it. Store the cord in the pod's pocket provided for this purpose.



# Packing tandem reserve

## 6. Installing the reserve parachute inside its POD.

a. Place the POD atop the parachute, then flip it all upside down while leaving a small space in front of the leading edge for subsequent line coiling.



Position the POD's elastic loop opposed to the suspension lines.



Do not pull the lines, they must not be under tension and best left slightly slackened atop the canopy.

b. Close the rear flap and two side flaps.

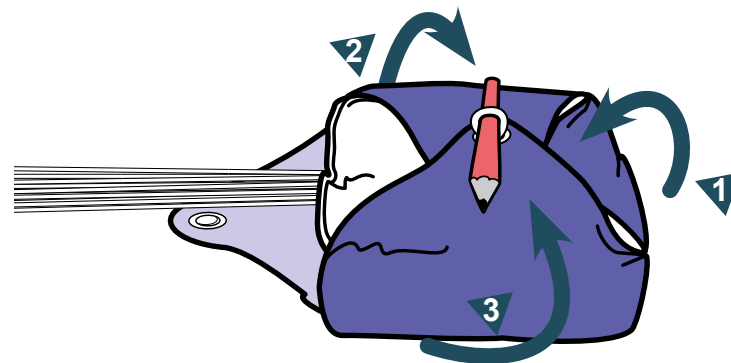

# Packing tandem reserve

## 6. Placing the parachute in its POD (continued).

c. Coil the lines into the space in front of the canopy while keeping 1.20 m of lines for the outer coiling.

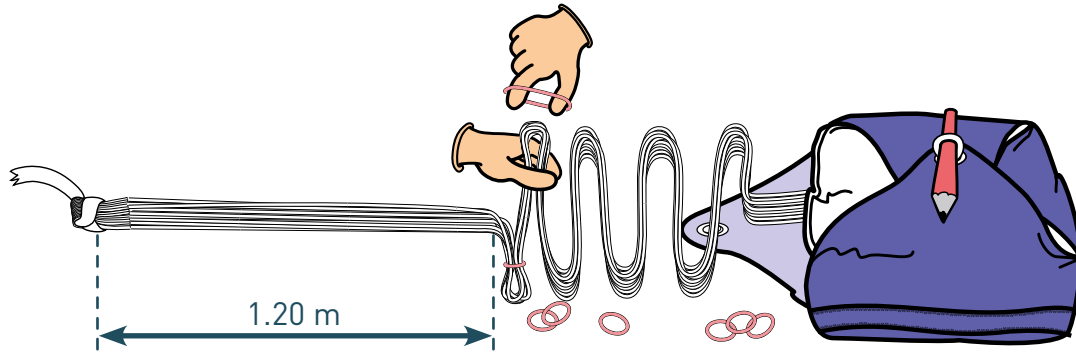

Installation marker.  
>> The suspension line loops must have a two fingers width.

d. Tuck away the coiled lines inside the space in front of the canopy while keeping a 1.20m line length for the subsequent outer coiling.

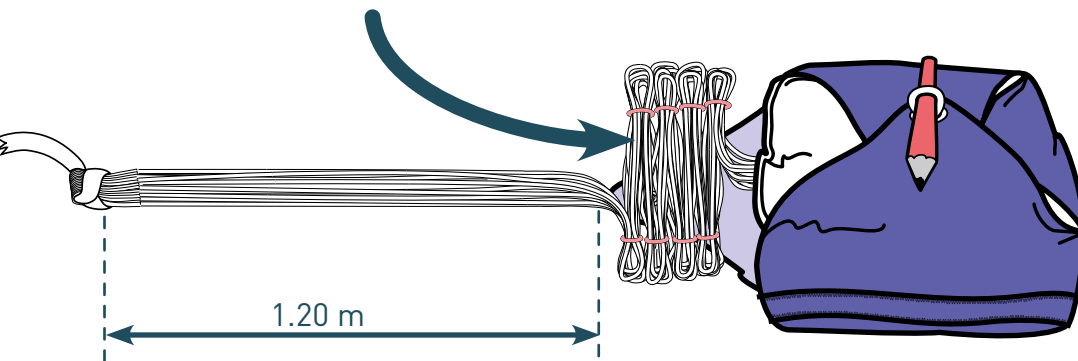

# Packing tandem reserve

## 7. Closing the POD.

a. Close the fourth flap and push a 5cm ( 3 fingers ) line loops through the POD elastic loop to secure the flaps in place.

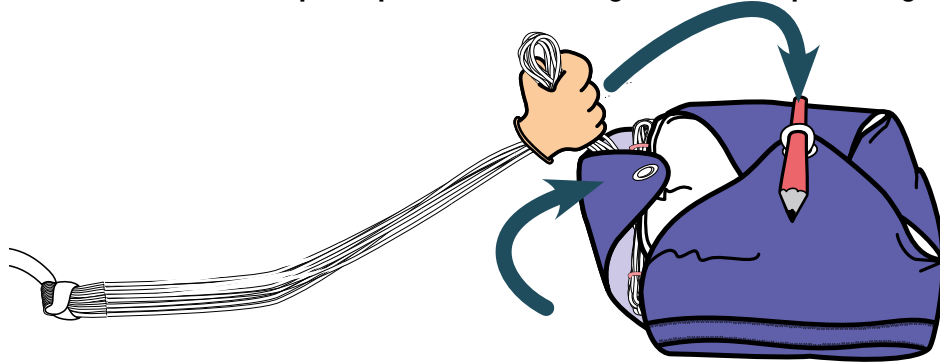

≈ 1 m loose lines.

b. Close the zip around the POD to reduce the reserve's volume

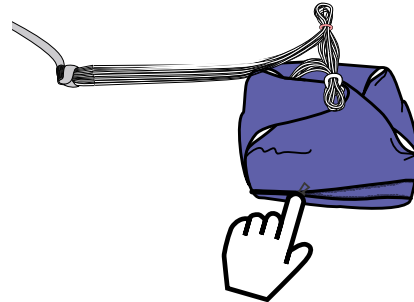

The folding procedure is completed.

c. Make sure that all the equipment needed for the packing procedure is accounted for, and that none of it was mistakenly left inside the folded parachute.



Installation marker.  
>> Loop width = 3 fingers.



A video about the use and folding of the parachute is available on our website.

## FLUID LIGHT Size S reserve parachute line chart.

\* Measurements made under a 5 kg. tension.

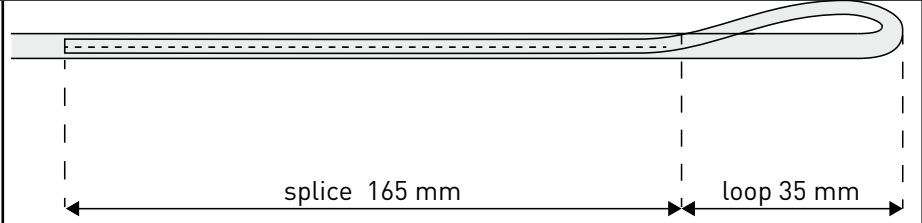
Line	Cut	Sewn	Line number	Line material		
B1	4175	3865	4	Liros DC201		
B2	4210	3900	8			
B3	4315	4005	8			
B4	4480	4170	4			
A1	2060	1750	1			
A2	2380	2070	4			
Apex	2875	2475	2	Cousin 2411	2 times 250 mm extra length ( 50 mm loop + 200 mm splice)	

### LINE LAYOUT

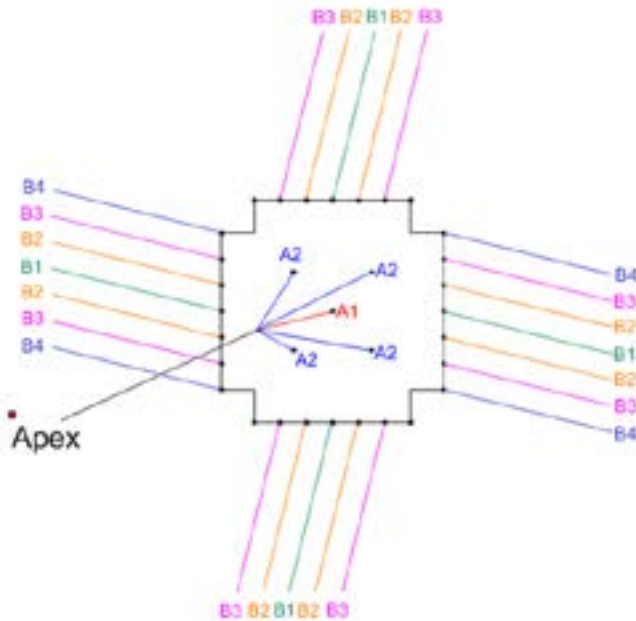

### POD SIZE S

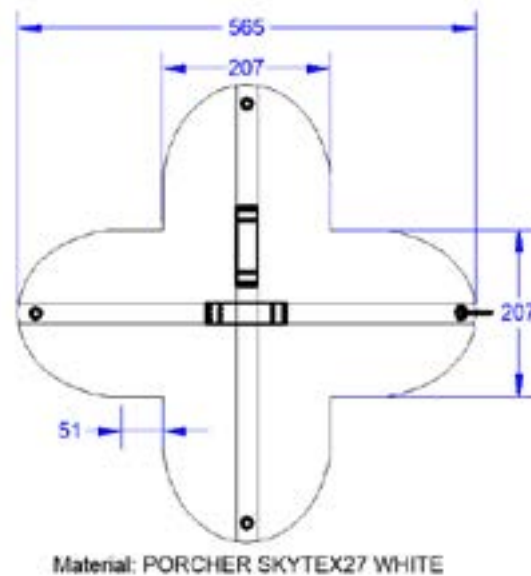

## FLUID LIGHT Size M reserve parachute line chart.

\* Measurements made under a 5 kg. tension.

Line	Cut	Sewn	Line number	Line material
B1	4550	4240	4	Liros DC201
B2	4590	4280	8	
B3	4700	4390	8	
B4	4885	4575	4	
A1	2230	1920	1	Liros 00099-1192
A2	2580	2270	4	
Apex	3115	2715	1	Liros 00099-1629

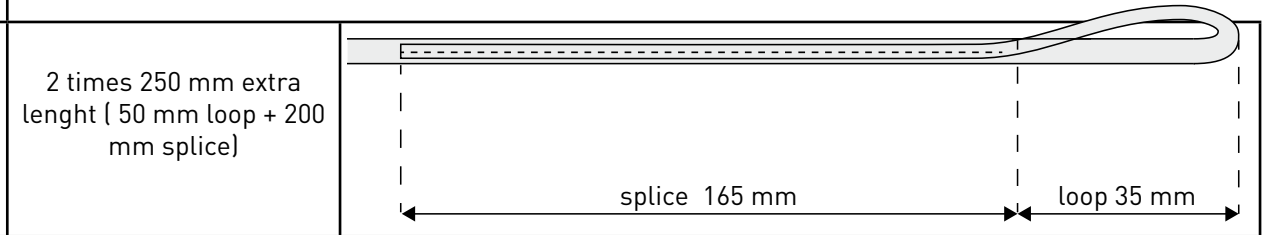

### LINE LAYOUT

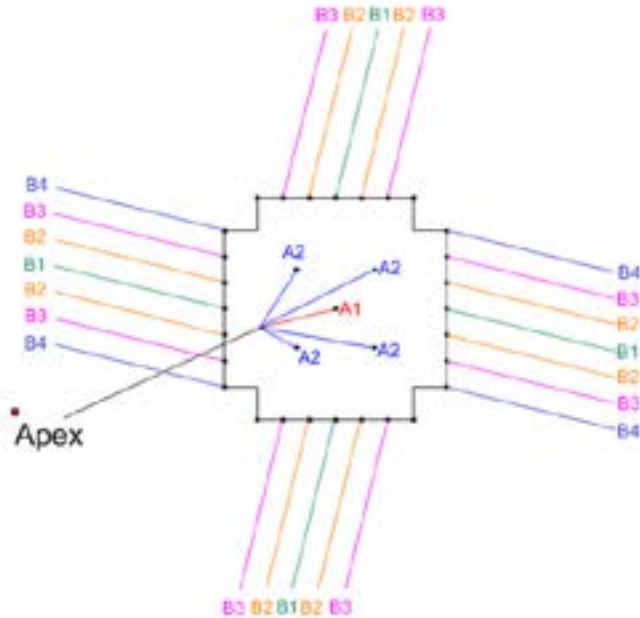

### POD SIZE M

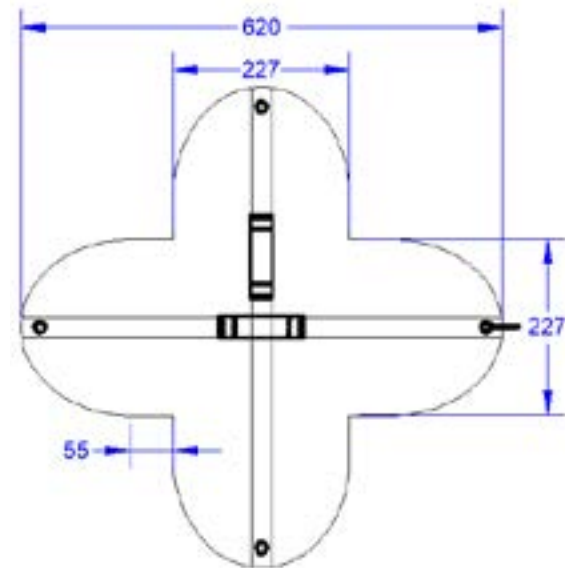

Material: PORCHER SKYTEX27 WHITE

# Measurement table

## FLUID LIGHT Size L reserve parachute line chart.

\* Measurements made under a 5 kg. tension.

Line	Cut	Sewn	Line number	Line material
B1	4925	4615	4	Liros DC201
B2	4965	4655	8	
B3	5090	4780	8	
B4	5290	4980	4	Liros 00099-1192
A1	2395	2085	1	
A2	2780	2470	4	
Apex	3350	2950	1	Liros 00099-1629

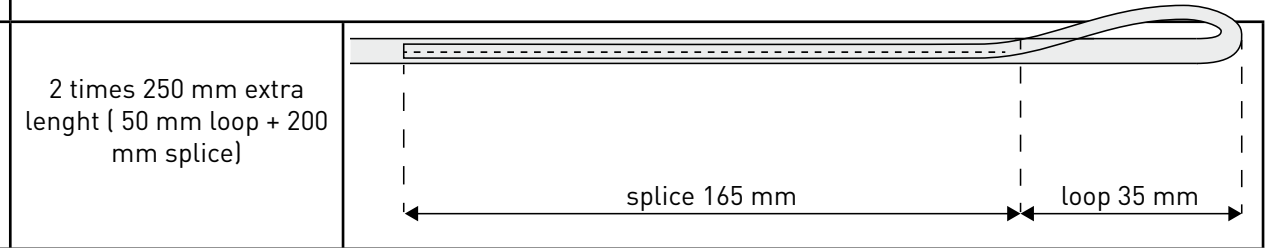

### LINE LAYOUT

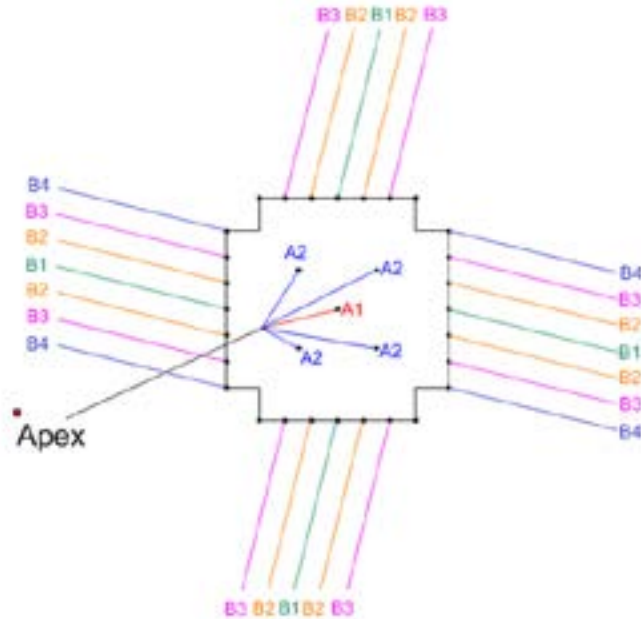

### POD SIZE L

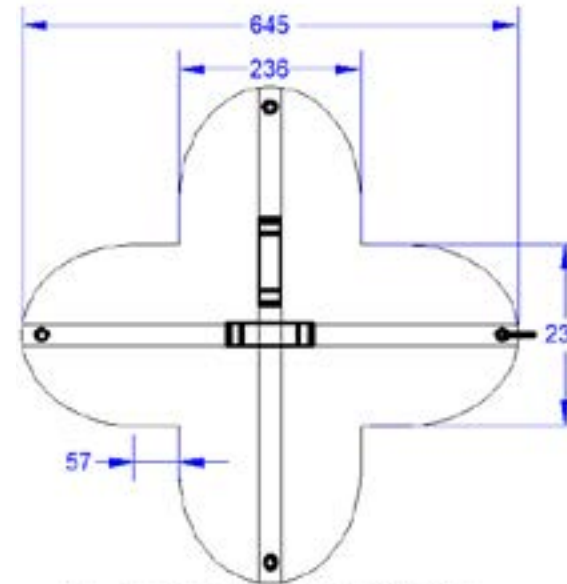

Material: PORCHER SKYTEX27 WHITE



## TANDEM FLUID LIGHT reserve parachute line chart.

\* Measurements made under a 5 kg. tension.

Line	Cut	Sewn	Line number	Line material	
B1	7055	6745	4	Liros DC201	
B2	7090	6780	8		
B3	7185	6875	8		
B4	7345	7035	8		
B5	7560	7250	4		
A1	3370	3060	1	Liros 00099-1192	
A2	3645	3335	4		
A3	3900	3590	4	Liros DC201	
Apex	4690	4290	2	Liros 00099-1629	

### LINE LAYOUT

### Schéma de principe du pod fourni :

SUSPENSION LINES LAYOUT

APEX LINES LAYOUT

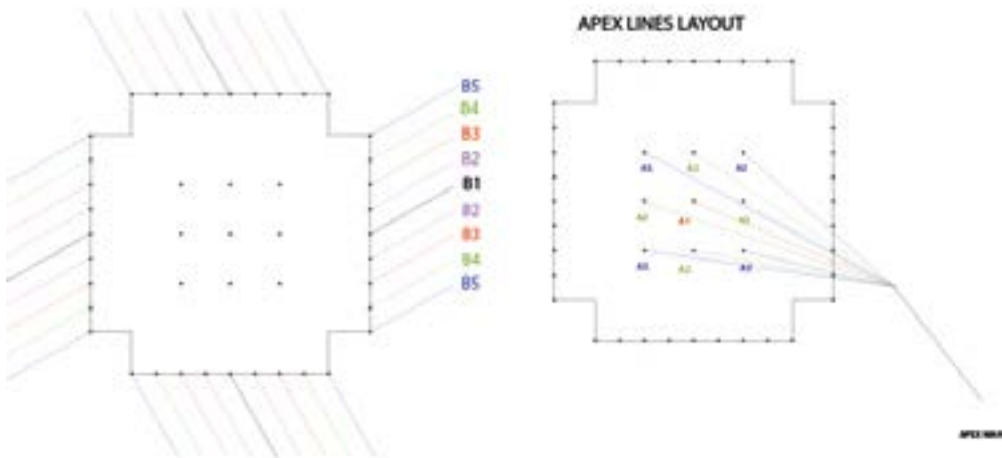

## MAINTENANCE

If wet, you will have to immediately dry your parachute to avoid any bacteria / fungi buildup. Gasoline contact, or any other solvent / chemical agent, can considerably decrease and compromise your reserve parachute's structural integrity. In the case, the parachute will have to be controlled and checked by a professional specialized outfit. The outer container ( pod or also called diaper ), can be washed independently from the parachute, with water and mild unscented soap, rinsed and dried. As for the parachute itself and its lines, use water only.

## Storage and transport.

When not in use, you must stow away your reserve parachute in a dry, cool, clean and UV rays free environment. During transport protect the harness against abrasion or UV deterioration (use a bag). Avoid long transports in wet conditions.

## REPACKING FREQUENCY

To guarantee a fast deployment sequence and proper care for your reserve parachute, you must open and repack it every six (6) months.

## LONGEVITY

Your reserve parachute was designed to last ten years if properly maintained as per manufacturer's recommendations. Pass that period, we will recommend you to have your parachute inspected at a professional certified outfit. The procedure should be implemented regularly throughout that ten year period.

## RECYCLING

Our materials have been specifically selected for their exceptional resilience and environmentally friendly abilities. None of the components used in the manufacturing of our reserve parachutes is environmentally harmful. The majority of the components used can be recycled.. We will ask you not to dispose of your old parachute with the regular trash but approach a specialized recycling facility instead. You can also bring it back to your SUPAIR dealer who will send it back to us.

## Repairs

In spite of using the highest quality products used during manufacturing, it is possible for your reserve to deteriorate through general use. If showing any sign of wear and tear, it should be sent for inspection and/or repairs at a professional certified facility.

## Hardware & Parts

- POD solar tandem with a zip, Please contact your SUPAIR reseller to purchase a new POD

## Materials

>> Lines

Liros DC201  
Liros 00099-1192  
Liros 00099-1629  
Cousin 2411

>> Fabrics

PORCHER PN9

## Warranty

SUPAIR takes great care in its product design and manufacturing. SUPAIR guarantees its parachutes two years from the date of purchase against any defect or design flaw that would arise under normal use. Product mishandling, excessive exposure to aggressive factors (such as over heating, intense sunlight (UV), high humidity, aggressive chemical agents and such) that would become harmful and damaging to the merchandise, would void the warranty.

## Disclaimer



Paragliding is an activity requiring specific skills and sound judgement. Learn how to fly within the environment of a certified paragliding school. Carry an insurance policy with you in addition to your pilot certification. Always mind and gauge your personal skills against the weather conditions of the day. Better be safe than sorry ! SUPAIR can not be held responsible for your paragliding decisions or activities. All other use or installation than those described in this user manual are not covered by SUPAIR's responsibility.



**This SUP'AIR product has been designed exclusively for paragliding. Any other activity such as skydiving or BASE jumping is absolutely forbidden.**



It is essential for you to wear a suitable head protection (certified paragliding helmet), adequate footwear and right clothing for the activity. Moreover, carrying a reserve parachute connected to your harness in flight is highly recommended.

## Pilot's gear.

## Eco-responsibility

Paragliding is an outdoor activity. You will fly in an environment for which you are responsible, so please take care :

- \* to respect the local flora and fauna
- \* do not throw your waste on the ground
- \* not to generate more noise than necessary.

Respecting those simple rules permit to preserve our environment and the paragliding activity.

This page will help you keep record of your FLUID LIGHT scheduled maintenance.

Purchase date	
Owner's name	
Name and stamp of the shop	

<input type="checkbox"/> Care <input type="checkbox"/> Resale	
Date	
Workshop's name/ Buyer's name	

<input type="checkbox"/> Care <input type="checkbox"/> Resale	
Date	
Workshop's name/ Buyer's name	

<input type="checkbox"/> Care <input type="checkbox"/> Resale	
Date	
Workshop's name/ Buyer's name	

<input type="checkbox"/> Care <input type="checkbox"/> Resale	
Date	
Workshop's name/ Buyer's name	



# SUPAIR

L I F E I S I N T H E A I R



**SUPAIR**

**Parc Altaïs**

**34 rue Adrastée**

**74650 Chavanod, Annecy**

**FRANCE**

**info@supair.com**

**+33(0)4 50 45 75 29**

**45°54.024'N / 06°04.725'E**